

INSTRUCTION MANUAL



MD485 RS-485 Multidrop Interface

Revision: 10/10



Copyright © 2003-2010
Campbell Scientific, Inc.

Warranty and Assistance

The **MD485 RS-485 MULTIDROP INTERFACE** is warranted by Campbell Scientific, Inc. to be free from defects in materials and workmanship under normal use and service for twelve (12) months from date of shipment unless specified otherwise. Batteries have no warranty. Campbell Scientific, Inc.'s obligation under this warranty is limited to repairing or replacing (at Campbell Scientific, Inc.'s option) defective products. The customer shall assume all costs of removing, reinstalling, and shipping defective products to Campbell Scientific, Inc. Campbell Scientific, Inc. will return such products by surface carrier prepaid. This warranty shall not apply to any Campbell Scientific, Inc. products which have been subjected to modification, misuse, neglect, accidents of nature, or shipping damage. This warranty is in lieu of all other warranties, expressed or implied, including warranties of merchantability or fitness for a particular purpose. Campbell Scientific, Inc. is not liable for special, indirect, incidental, or consequential damages.

Products may not be returned without prior authorization. The following contact information is for US and International customers residing in countries served by Campbell Scientific, Inc. directly. Affiliate companies handle repairs for customers within their territories. Please visit www.campbellsci.com to determine which Campbell Scientific company serves your country.

To obtain a Returned Materials Authorization (RMA), contact Campbell Scientific, Inc., phone (435) 753-2342. After an applications engineer determines the nature of the problem, an RMA number will be issued. Please write this number clearly on the outside of the shipping container. Campbell Scientific's shipping address is:

CAMPBELL SCIENTIFIC, INC.

RMA#_____

815 West 1800 North

Logan, Utah 84321-1784

For all returns, the customer must fill out a "Declaration of Hazardous Material and Decontamination" form and comply with the requirements specified in it. The form is available from our website at www.campbellsci.com/repair. A completed form must be either emailed to repair@campbellsci.com or faxed to 435-750-9579. Campbell Scientific will not process any returns until we receive this form. If the form is not received within three days of product receipt or is incomplete, the product will be returned to the customer at the customer's expense. Campbell Scientific reserves the right to refuse service on products that were exposed to contaminants that may cause health or safety concerns for our employees.

MD485 Table of Contents

PDF viewers note: These page numbers refer to the printed version of this document. Use the Adobe Acrobat® bookmarks tab for links to specific sections.

1. Introduction	1
2. Specifications	1
3. System Components	2
3.1 MD485 RS-485 Multidrop Interface	2
3.1.1 Ground Lug	2
3.1.2 Indicator LEDs	2
3.1.3 Configuring the MD485	3
3.2 Power Supplies	4
3.3 RS-485 Cable	4
3.4 Serial Cables	5
4. Quick Start	5
5. System Configuration	8
5.1 Transparent Communication	9
5.2 MD9 Emulation	11
5.3 PakBus Networking	12
6. Combining with Other Devices	12
7. Call-back	13
8. Wiring Specifications	13
8.1 RS-485 Line Length	13
8.2 Grounding	13
8.3 Protection and Isolation	14
8.4 Termination	14
8.5 Summary	14
A. Phone to MD485 Network	A-1
B. RF401 to MD485 Network	B-1
B.1 Connection using a PS100 with A100	B-1
B.2 Connection using a Null Modem Cable	B-4

C. MD485 to RF401 Network C-1
 C.1 Connection using a PS100 with A100..... C-1
 C.2 Connection using a Null Modem Cable C-4

D. Digital Cellular Modem to MD485 Network..... D-1
 D.1 RavenXT-series, Raven100, and Raven110 Digital Cellular
 Modems D-1
 D.2 Redwing100 and Redwing105 Digital Cellular Modems D-4

E. NL100 to MD485 Network..... E-1

F. MD485 to CC640 Digital Camera F-1

G. MD485 to AVW200 Interface G-1

H. MD485 Port Pin Descriptions H-1

Figures

1. The MD485 has a ground lug that should be attached to earth ground
 and LEDs that indicate traffic on the ports 2

2. MD485 Setup Menu..... 3

3. RS-485 Connections and Grounding 5

4. MD485 Basic Point-to-Point Network..... 6

5. Point-to-Point LoggerNet Network Map 7

6. MD485 Point-to-Multipoint Network..... 8

7. RS-232 to CS I/O Conversion..... 9

8. Long Distance RS-232 to CS I/O Conversion 10

9. MD485 to Serial Printer..... 10

10. Transparent Point-to-Multipoint Network 11

A-1. Telephone to MD485 Conversion A-1

A-2. LoggerNet Phone to MD485 MD9 Emulation Setup A-4

B-1. RF401 to MD485 Conversion..... B-1

B-2. LoggerNet RF401 to MD485 MD9 Emulation Setup..... B-3

B-3. LoggerNet PakBus Networking Setup..... B-7

C-1. MD485 to RF401 Conversion..... C-1

D-1. Digital Cellular Modem to MD485 Conversion D-1

D-2. LoggerNet Digital Cellular Modem to MD485 MD9
 Emulation Setup..... D-6

D-3. LoggerNet Digital Cellular Modem to MD485 PakBus
 Networking Setup D-8

E-1. NL100 to MD485 Conversion E-1

E-2. NL100 to MD485 Conversion for MD9 Emulation..... E-2

E-3. LoggerNet NL100 to MD485 PakBus Networking Setup E-5

F-1. Camera to MD485 Connection..... F-1

G-1. MD485 to AVW200 Connection (point-to-point) G-1

G-2. Deployment tab in DevConfig with proper MD485 configuration.... G-2

Tables

1. Specifications.....	1
2. Lacking 12 V on CS I/O Pin 8.....	6

MD485 RS-485 Multidrop Interface

1. Introduction

The MD485 is an intelligent RS-485 interface. It is configurable to use any two of its three interface ports (RS-485, RS-232 and CS I/O) at a time.

The MD485 device's primary function is to provide a connection to an RS-485 network (using CS I/O or RS-232). It can also be used to provide an RS-232 connection to a datalogger's CS I/O port (SDC or ME).

MD485s may be networked thereby permitting a computer to address and communicate with multiple dataloggers. There are two RS-485 terminals to allow for easy networking. Both are connected to the same port internally, so either may be used for an RS-485 connection. For networking, one may be used for input and the other for output. Total cable length may be up to 4000 feet.

With the communication link initiated and controlled by a PC using Campbell Scientific's LoggerNet or similar software, the operation of the MD485 in the system is transparent to the user.

2. Specifications

TABLE 1. Specifications

Size: 6.25 x 2.5 x .75 in. (15.88 x 6.35 x 1.91 cm)

Weight: 4.5 oz. (127.6 g)

Accessories: RS-232 cable, SC12 cable, 3-pin Terminal Block (2)

Voltage: 12 Volts from datalogger or Transformer (#15966)

Current:

Standby	1.2 mA
Communicating	2-7 mA

Power:

Standby	14.4 mW
Communicating	24-84 mW

ESD:

Air Discharge	Complies with IEC61000-4-2, test level 4 (± 15 kV)
Contact Discharge	Complies with IEC61000-4-2, test level 4 (± 8 kV)

Surge: Complies with IEC61000-4-5, test level 3 (± 2 kV, 2 ohms coupling impedance)

Temperature range: -25 to +50°C

Baud rates: 115.2K, 57.6K, 38.4K, 19.2K, 9600, 1200

Communication cable: CABLE2TP-L two-twisted-pair cable

3. System Components

3.1 MD485 RS-485 Multidrop Interface

3.1.1 Ground Lug

The MD485 has a GND lug (see Figure 1). Connect this GND lug to earth ground with 8 AWG wire. This connection should be as short as possible.

3.1.2 Indicator LEDs

The MD485 has two red LEDs. When 12V power is applied the LEDs light for one second. The LEDs then begin flashing once every two seconds, while there is no activity on the ports.

When the RS-485 port is an active port, the LED nearest that connector (labeled B in Figure 1) indicates traffic on the RS-485 port, and the other LED (labeled A) indicates traffic on the other active port (CS I/O or RS-232). When CS I/O and RS-232 are the active ports, the LED between the CS I/O connector and the RS-232 connector (A) indicates activity on the CS I/O port, and the other LED (B) indicates traffic on the RS-232 port. When data is being received and transmitted, the LEDs will flash. The LED for the port that is transmitting will be on more than the LED for the receiving port.

The LED nearest the RS-485 (B) connector will blink twice a second to indicate an RS-485 receiving error. This most likely indicates a wiring problem between the RS-485 ports of the base and remote MD485s.

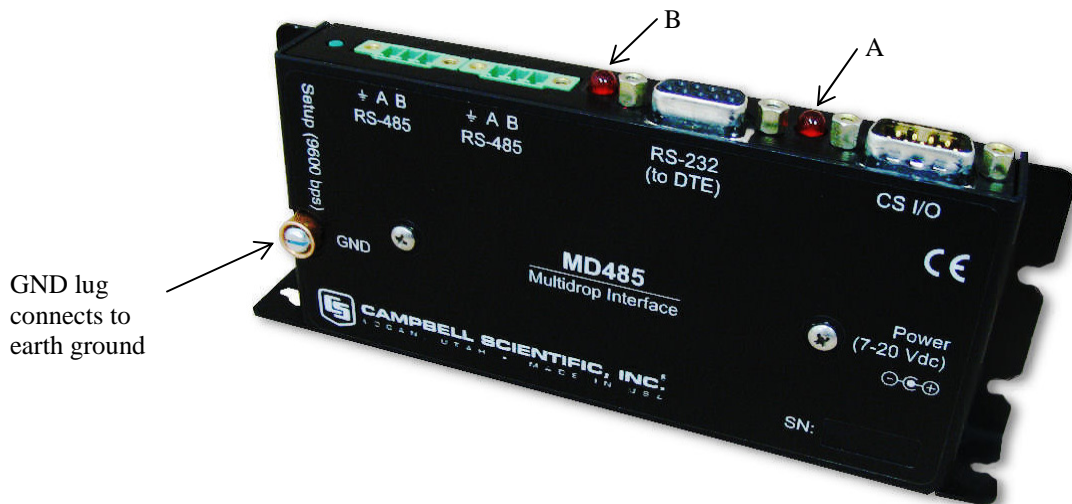

FIGURE 1. The MD485 has a ground lug that should be attached to earth ground and LEDs that indicate traffic on the ports.

3.1.3 Configuring the MD485

The MD485 is typically configured using the Device Configuration (DevConfig) utility, which is included with PC400 and LoggerNet and can be downloaded at no charge from our web site. Using DevConfig, you select and configure the active ports and choose the communication mode (see Figure 2). Changed settings are saved in Flash memory.

Alternatively, a Setup Menu can be accessed by connecting the MD485's RS-232 port to a PC running a terminal program such as Hyper Terminal™ or Procomm™ (always 9600 baud, 8-N-1) and pressing the "Setup" button on the MD485. Changed settings are saved in flash memory by selecting menu item "7" as you exit the Setup Menu. If left idle, the Setup Menu will time out 2 minutes after the last received character and exit without saving any parameter changes with the message "Setup Timeout."

NOTE

A datalogger can remain connected to the CS I/O port while setting MD485 parameters on the RS-232 port, although CS I/O communications would be inactive until exiting DevConfig or the Setup Menu.

The screenshot displays the 'Deployment' tab of the DevConfig utility. The configuration settings are as follows:

- Serial Number: 0
- Active Ports: RS-232 and RS-485
- CS I/O Mode: SDC Address 7
- Protocol Configuration: PakBus Networking
- CS I/O ME Baud Rate: 9600
- RS-232 Baud Rate: 38.4k
- RS485 Baud Rate: 38.4k
- MD9 Address: 255

RS-485 Baud Rate
Specifies the baud rate that will be used on the RS-485 port.

FIGURE 2. MD485 Setup using DevConfig

NOTE The baud rate for each port is set independently, so they can be different. However, in some instances, mismatched baud rates can cause an MD485 buffer overflow and create communication failures. Regardless of the baud rates set on other interface ports, the RS-485 ports of all MD485s in a system must be set to the same baud rate.

3.2 Power Supplies

The typical base station MD485 connected directly to a PC uses a wall transformer to supply 12 VDC power. You can order the optional wall transformer (CSI Item # 15966). In a phone to MD485 base station configuration (without datalogger) the MD485 can obtain power from a PS100 Power Supply with an A100 Null Modem Adapter. (The PS100 with an A100 attached replaces the PS512M. Either may be used whenever the PS100/A100 is referenced in this manual.)

The typical remote MD485 will be connected to a datalogger CS I/O port and get its 12 V power from that. If your datalogger is an earlier unit without 12 V on CS I/O pin 8 (see Table 2) or if the remote MD485 is connecting to a datalogger RS-232 port, there is an optional Field Power Cable available (CSI Item # 14291) with tinned leads to connect to power at the datalogger 12 V output terminals and barrel connector to plug into the MD485's "DC Pwr" jack. If 120 VAC is available at the site, the wall transformer (CSI Item # 15966) is an option.

A 12 V supply may connect to either the MD485's "DC Pwr" jack or CS I/O pin 8 (or both, since there is diode isolation between supply inputs). The 12 V supply inputs are diode protected against the application of reverse polarity power.

3.3 RS-485 Cable

The connection between MD485s is made with the CABLE2TP-L two-twisted-pair cable with shield and Santoprene jacket. Insulation colors of the twisted pair are red/black and green/white. One pair is used for the differential data ("A" connects to "A"; "B" connects to "B"), and one line of the other twisted pair is used for the signal ground (third connection on the MD485 terminal block). This is shown in Figure 3. The cable shield should be connected to a chassis or earth ground (NOT the signal ground) at one end as shown in that figure.

When connecting to equipment that uses "-" and "+" terminal markings, the MD485 "A" terminal is connected to the "-" terminal and the MD485 "B" terminal is connected to the "+" terminal.

If an application requires both the maximum distance (4000 ft) and the highest data rate (115k) of the MD485, a better quality cable, such as a polyethylene data cable could be used.

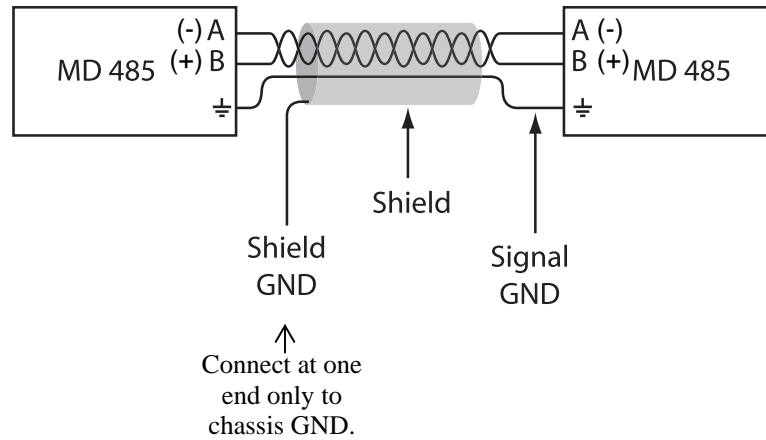

FIGURE 3. RS-485 Connections and Grounding

3.4 Serial Cables

In an MD485 base station, a straight-through DB9M/DB9F RS-232 cable will connect from the MD485's RS-232 port to the PC COM port. This cable is included with the MD485.

A remote MD485 normally uses the included SC12 cable to connect the MD485's CS I/O port to the datalogger's CS I/O port.

A remote MD485 can be connected to a CR200(X)-series, CR800, CR850, CR1000, CR3000, or CR5000's RS-232 port with a null modem DB9M/DB9M cable (CSI Item # 18663).

4. Quick Start

This section is intended to serve as a "primer" enabling you to quickly build a simple system and see how it operates. This section describes in five steps how to set up a pair of MD485s in a direct connect, point-to-point network. We recommend that you do this before undertaking field installation.

For this system you will need the following hardware or the equivalent:

1. Two MD485s
2. Transformer (Item # 15966)
3. Serial cable for PC COM port to MD485 RS-232 port (included with MD485)
4. SC12 cable (included with MD485)
5. CSI Datalogger (such as CR1000, CR3000, CR10X, or CR23X)
6. Field Power Cable (Item # 14291) if older datalogger or wiring panel doesn't have 12 V on pin 8 of CS I/O port
7. CABLE2TP-L 2-twisted-pair cable with shield and Santoprene jacket

You will also need:

1. A PC with one available COM port
2. LoggerNet, PC400, or PC208W installed

Step 1 – Set Up Base MD485

- a. Connect serial cable from PC COM port to base MD485 RS-232 port.
- b. Plug transformer into AC outlet and plug barrel connector into base MD485 “DC Pwr” jack. You will see both red LEDs light immediately for 1 second. Both LEDs then begin to flash once every 2 seconds.
- c. Using DevConfig or the MD485 setup menu as explained in Section 3.1.3, change the active ports of the base MD485 to “RS-232 and RS-485.” All other options can be left in their default state.

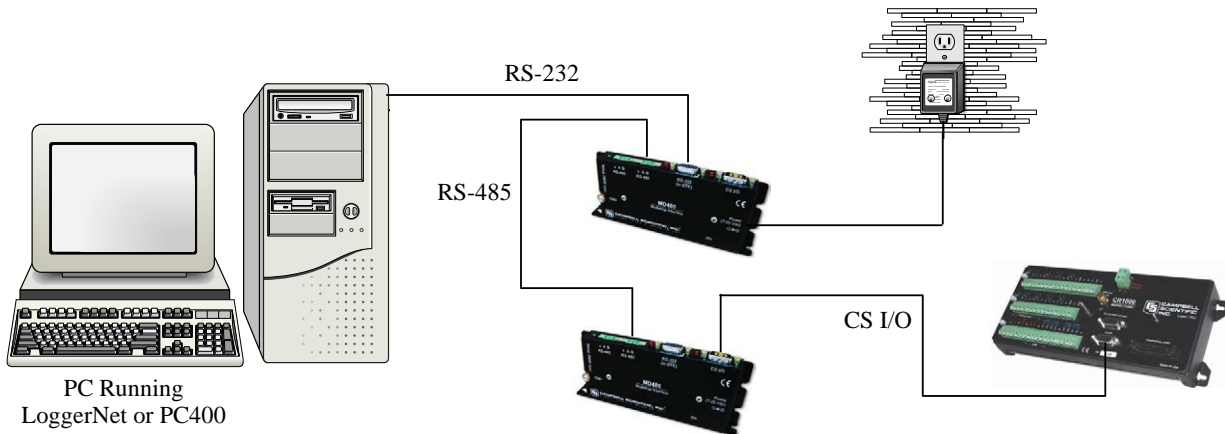

FIGURE 4. MD485 Basic Point-to-Point Network

Step 2 – Set Up Remote MD485

- a. Connect SC12 cable from datalogger CS I/O port to remote MD485 CS I/O port. Current datalogger/wiring panel CS I/O ports apply power to the remote MD485.

With older dataloggers lacking 12 V on pin 8 (see Table 2), you can power the MD485 using a Field Power Cable (see above hardware list) between the datalogger’s 12 V (output) terminals and the MD485’s “DC Pwr” jack.

TABLE 2. Lacking 12 V on CS I/O Pin 8	
EQUIPMENT	SERIAL NUMBER
CR500	< 1765
CR7 700X Bd.	< 2779
21X	< 13443
CR10 Wiring Panels	All (black, gray, silver)
PS512M Power Supply	< 1712

When you connect power to the MD485 (through the SC12 cable or the optional Field Power Cable) you should see the power-up sequence of the red LEDs described in Step 1 (assuming datalogger is powered).

Current dataloggers and wiring panels (not mentioned in Table 2) provide 12 V on pin 8. For older products not listed, check for 12 V between CS I/O connector pin 8 and pin 2 (GND) or contact Campbell Scientific.

- b. Use default settings of MD485.

Step 3 – Connect Base MD485 to Remote MD485

- a. Connect the CABLE2TP cable from the 3-pin terminal block on the Base MD485 to the 3-pin terminal block on the Remote MD485 as described in Section 3.3.

Step 4 – PC400/LoggerNet/PC208W Set-up

- a. The next step is to run PC400/LoggerNet/PC208W and configure it to connect to the datalogger via the MD485 point-to-point network you have set up. The MD485 in a point-to-point network can operate transparent to PC400/LoggerNet/PC208W. Using the EZSetup Wizard in PC400 or LoggerNet, transparent communications is set up as if it is a direct connect. If not using the EZSetup Wizard, simply add a datalogger to a COM port in the Device Map.

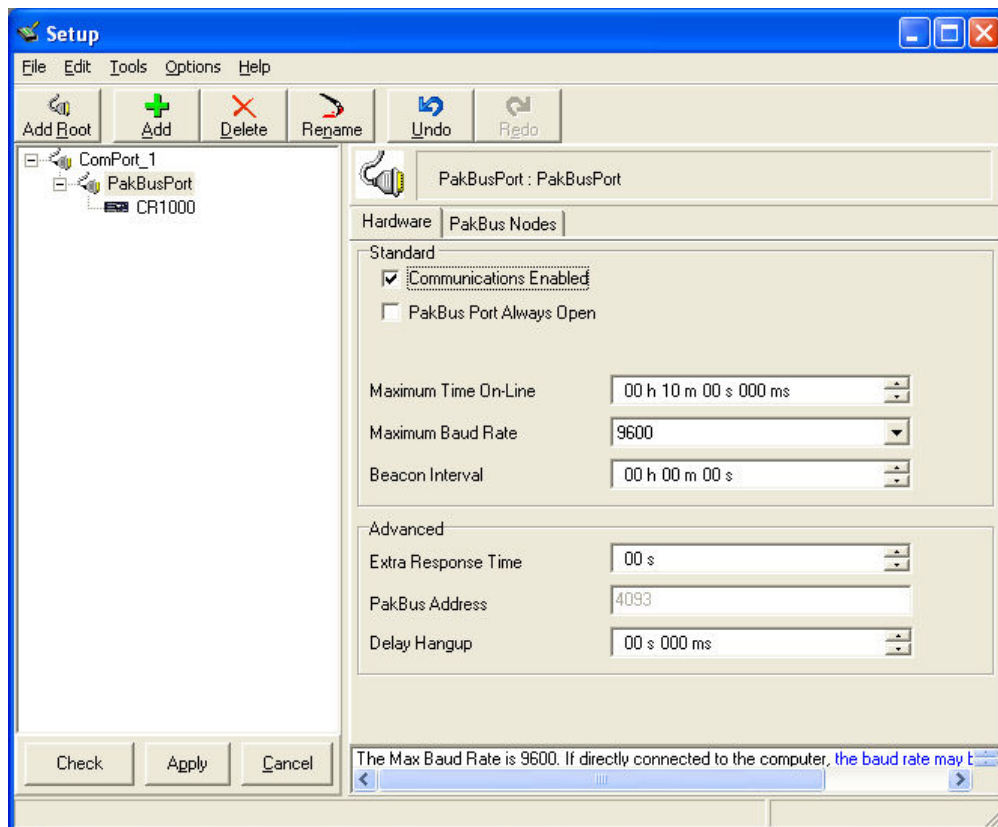

FIGURE 5. Point-to-Point LoggerNet Network Map

- b. Set the Maximum Baud Rate for 9600 baud which is the rate at which the MD485 communicates by default. The datalogger “Extra Response Time” can be left at 0.

Step 5 – Connect

You are now ready to Connect to your datalogger using PC400, LoggerNet, or PC208W Connect screen.

Datalogger program transfer and data collection are now possible.

5. System Configuration

The block diagram in Figure 6 depicts the connection of a computer to a network of Campbell Scientific dataloggers using MD485s.

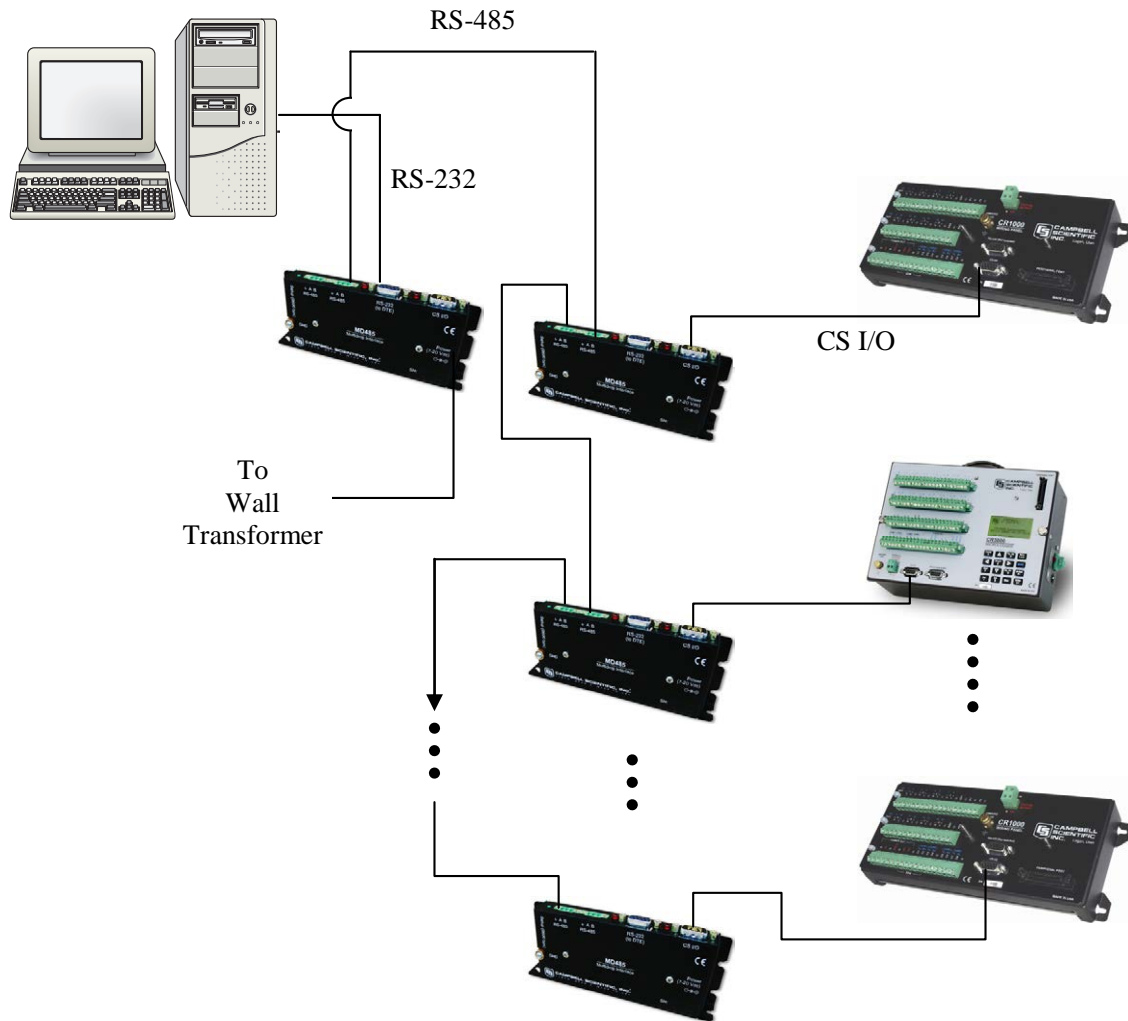

FIGURE 6. MD485 Point-to-Multipoint Network

The base MD485 is connected to the computer's COM port with a serial cable. A transformer supplies +12 VDC power to the MD485.

The MD485 at the computer is connected to one or more remote MD485s with the CABLE2TP cable.

The MD485 at the datalogger is connected via an SC12 cable (supplied with the MD485) and is powered from the datalogger CS I/O port.

Each MD485 includes (2) green 3-pin terminal blocks to allow for cable connections.

5.1 Transparent Communication

When configured as a transparent device, the MD485 simply passes serial data from one interface to the other as quickly as possible without translation. If communication rates are different, the MD485 can buffer up to 1000 bytes.

Functioning as a transparent device, the MD485 becomes somewhat protocol independent. It acts as a way to get from one physical interface to another. In this mode the MD485 uses what is called "send-data" transmit control. The 485 transceiver is normally set to receive. When data needs to be transmitted on the RS-485 link, the driver is enabled, and stays enabled for 1 character tone after the last byte is sent. After this time, the transceiver switches back to receiving.

When using the EZSetup Wizard provided in PC400 and LoggerNet, select Direct Connect for the Connection Type. In transparent mode, the MD485 does not need to be represented in the network map of LoggerNet or PC208W.

Figure 7 shows an MD485 being used as an RS-232 to CS I/O interface converter. The MD485 is powered by the datalogger through the CS I/O interface. RS-232 and CS I/O are chosen as the active ports in the MD485 Setup Menu. In this configuration, the MD485 acts as a full-duplex device, fully compatible with all datalogger protocols and CS I/O configurations.

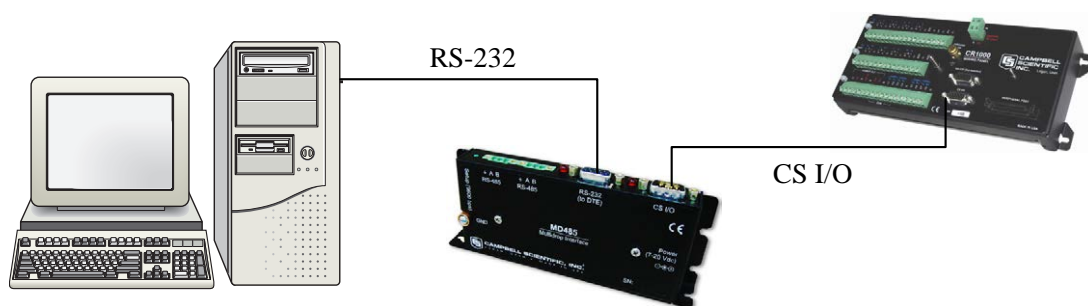

FIGURE 7. RS-232 to CS I/O Conversion

Figure 8 would allow the longer distance characteristics of RS-485 to be taken advantage of, while still providing an RS-232 interface for the PC and using the CS I/O interface on the datalogger. A transformer is required to power the MD485 closest to the PC. The base MD485 has RS-232 and RS-485 chosen as

active ports, while the remote MD485 has the active ports set to RS-485 and CS I/O. With the MD485s configured as transparent devices, the only protocol limitation is the fact that RS-485 is a half-duplex interface. If used with traditional datalogger communication, PC software must take the half-duplex nature of the link into account. For array-based dataloggers, this is accomplished by PC400, LoggerNet, or PC208W.

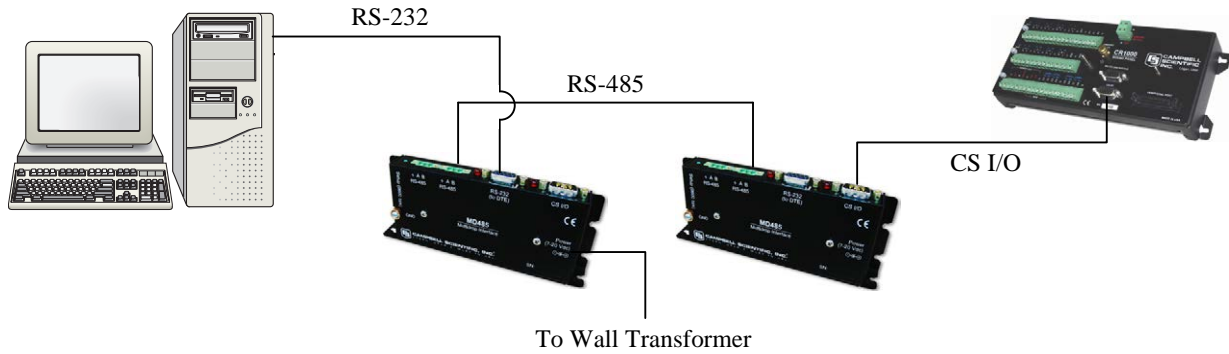

FIGURE 8. Long Distance RS-232 to CS I/O Conversion

Figure 9 shows how an MD485 could be used to send one-way data to a serial printer via a P96 instruction. A null modem may be required in the RS-232 line for the printer. A transformer would be needed to power the MD485 nearest the printer, because the MD485 is not port-powered from the RS-232 or RS-485 ports. In this configuration, the MD485 near the datalogger has CS I/O and RS-485 as active ports. The CS I/O port should be configured to Addressed Print Device which emulates a CSI SC99. RS-485 and RS-232 are the active ports for the MD485 near the printer. Since printer data is one-way only, the fact that the RS-485 interface is half-duplex is not an issue.

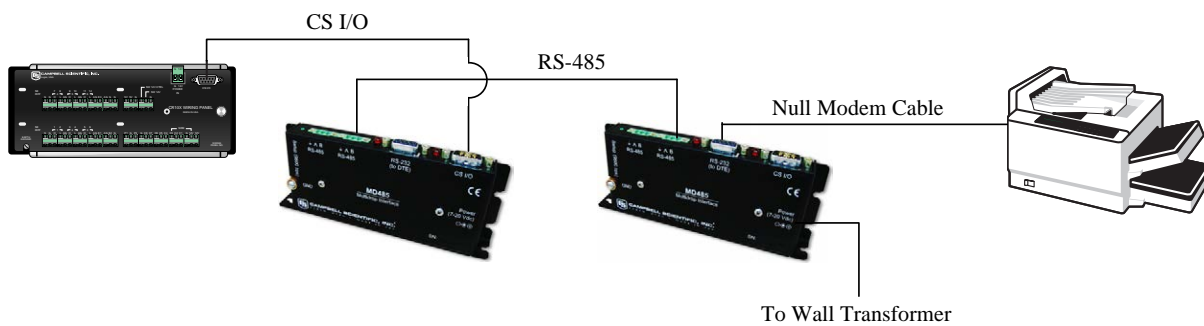

FIGURE 9. MD485 to Serial Printer

Figure 10 shows the MD485 used in a point-to-multipoint configuration. With the MD485s in transparent mode, only a master-slave protocol is supported. MODBUS is the only such protocol supported by CSI dataloggers and commonly used in the SCADA industry.

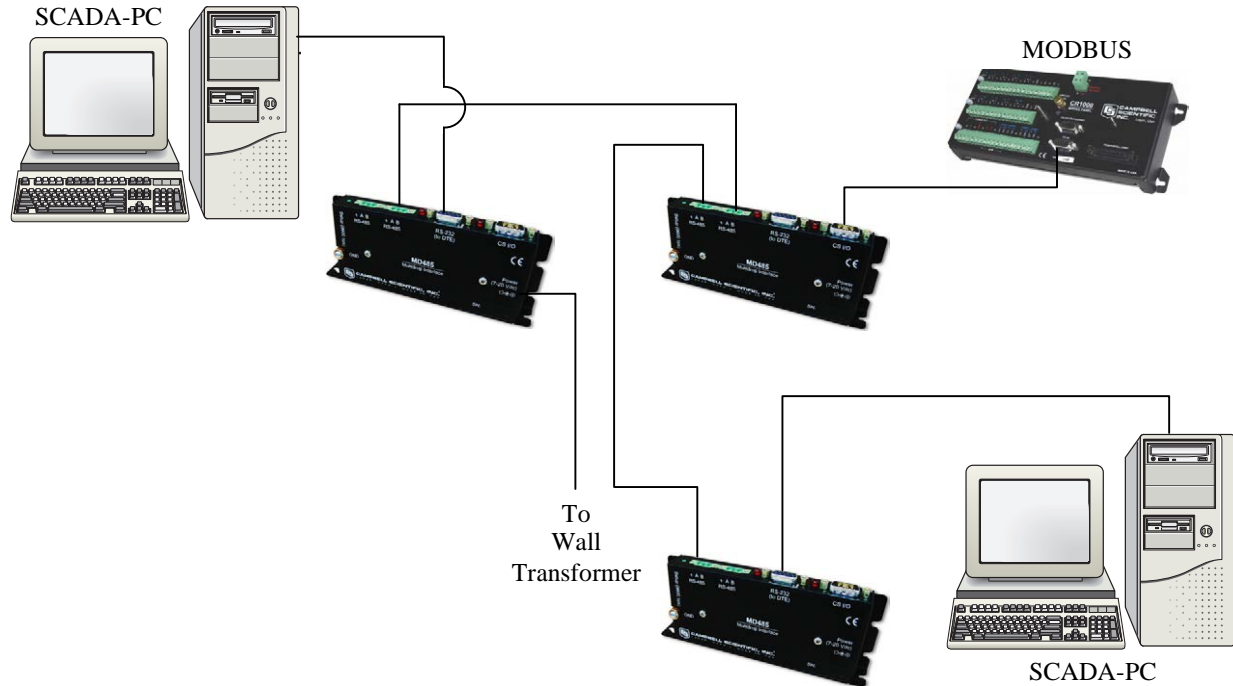

FIGURE 10. Transparent Point-to-Multipoint Network

5.2 MD9 Emulation

In MD9 emulation mode, the MD485 mimics the link-oriented dialing characteristics of the MD9. Note that the RS-485 interface is not physically compatible with the coaxial cable used by the MD9, so an MD485 cannot be used with an MD9. The MD9 emulation mode is not used with PakBus dataloggers, such as the CR800, CR850, CR1000, or CR3000.

The MD485 Setup Menu is used to put the device into MD9 emulation mode. When this option is chosen for the communication mode, an MD9 address must also be assigned. The base MD485 should be given address 255. Remote MD485s can be assigned addresses between 1 and 254.

In MD9 emulation mode, the MD485 looks like an MD9 to the PC, thus allowing legacy software to use an MD485 network as if it were an MD9 network. In the LoggerNet Setup Menu, an MD9Base is inserted at the appropriate point in the device map to represent the base MD485. Then an MD9Remote representing each remote MD485 in the network is connected to the MD9Base. The appropriate address for each remote MD485 must be entered into the address field. The corresponding datalogger is then connected to each remote in the network map.

If using PC208W, an MD9 Modem is inserted into the network map to represent the base MD485. The remote MD485s are not shown in the network map. Rather, the dataloggers are directly attached to the MD9 Modem. The address of each remote MD485 is entered in the "Switch Setting of Remote MD9" field of the corresponding datalogger.

5.3 PakBus Networking

When configured to use PakBus protocol, the MD485 makes use of the PakBus/Mdrop protocol on the RS-485 side. This allows reliable peer-to-peer networking of multiple devices over the three-wire RS-485 interface.

When the communication mode is set to PakBus Networking, the MD485 does not need to be represented in the device map of LoggerNet or PC208W. The dataloggers are simply attached to a PakBusPort.

When using PakBus Networking, dataloggers must be set up with PakBus addresses. They must also have beacons or neighbor filters set up as appropriate. (Beaconing is used for most applications. Networks with RF401s use neighbor filters.)

In PakBus Networking mode, datalogger-to-datalogger communication is possible.

6. Combining with Other Devices

Besides the “direct” to PC communications described in the Quick Start and System Configuration sections, it is possible to combine methods in datalogger communications.

NOTE

When using the MD9 emulation, PC400 software does not support these combined communication options; use either LoggerNet or PC208W software.

Some combined communications examples:

- 1) Phone to MD485: PC to external modem to COM220 to PS100 with A100 to MD485 to MD485 to datalogger (see Appendix A)
- 2) RF401 to MD485: PC to RF401s then through null modem cable (or PS100 with A100) to MD485s to datalogger (see Appendix B)
- 3) MD485 to RF401: PC to MD485s then through null modem cable (or PS100 with A100) to RF401s to datalogger (see Appendix C)
- 4) Cellular Digital Modem to MD485: PC to modem to Cellular Digital Modem then through null modem cable to MD485 to MD485 to datalogger (see Appendix D)
- 5) Network to MD485: PC to Internet to NL100 to MD485 to datalogger (use LoggerNet IPPort or PC208W socket, remote IP address, port number, see Appendix E)

The MD485 can also be used with the CC640 digital camera and the AVW200 Vibrating Wire Interface. When used with the CC640, the MD485 allows the distance between the camera and a PakBus datalogger to exceed 25 feet (see Appendix F). It is desirable to use the MD485 with an AVW200 for locations where wireless communication is impractical, but the distance between AVW200 interfaces needs to be extended (see Appendix G).

7. Call-back

Datalogger initiated communication, commonly referred to as “call-back,” is possible through MD485s in transparent mode. In order to do call-back, LoggerNet Setup, MD485 Configuration and Hardware should be done as described in the Transparent Communication section of Appendix A with two changes in the LoggerNet Setup. The ComPort must have “Call-back Enabled” checked and the datalogger must have the “Call-back ID” entered to match the Call-back ID in the P97 instruction of the Edlog program.

For information on how to program the datalogger for call-back, see the appendix covering Call-back or Datalogger Initiated Communication in the datalogger manual.

8. Wiring Specifications

8.1 RS-485 Line Length

The EIA/TIA RS-485 communications standard, an upgrade of RS-422, supports 32 devices (driver/receiver pairs) in a party line or multi-drop mode, on a cable of up to 4,000 feet.

The standard specifies that each device has a “unit load” of not more than 12k ohm. It does not specify cable type or data rate.

The MD485 has a 1/8-unit-load receiver input impedance (96k ohm) that allows up to 256 transceivers on the bus. Practical network design will be more of a limitation than the electrical load limit of 256 nodes for the MD485.

The RS-485 data transceivers used in the MD485 feature fail-safe circuitry, which guarantees a logic-high receiver output when the receiver inputs are open or shorted. Because of this no “biasing resistors” need to be used. They also feature reduced slew-rate drivers that minimize EMI and reduce reflections. Because of this, termination resistors do not need to be used for most applications.

8.2 Grounding

The MD485 has a ground lug. Connect this ground lug to earth ground with an 8 AWG wire. This connection should be as short as possible.

The differential signaling of RS-485 does not require a signal ground to communicate. The standard allows for a common-mode voltage (V_{cm}) of -7 to +12 V. As long as the MD485 local grounds do not exceed this common-mode voltage limit, the RS-485 communication will work fine.

Over a distance of hundreds or thousand of feet, there can be significant differences in the voltage level of “ground”; it can easily extend beyond the common-mode voltage limits of RS-485. The signal ground wire serves to tie the signal ground of each node to one common ground, which is within the common-mode voltage of the RS-485 specification.

The RS-485 specification also recommends connecting a 100 ohm resistor of at least 0.5 W in series between each node's signal ground and the network's ground wire. This resistor is in the MD485, between the terminal block connection marked with the ground symbol and the MD485 power ground. This way, if the ground potentials of two nodes vary, the resistors limit the current in the ground wire.

See Figure 1, Figure 3, and Section 3.3 for more information on ground connections.

8.3 Protection and Isolation

The MD485 incorporates gas tubes and multilayer varistors on the RS-485 port for protection against ESD and surge. The MD485 passes IEC61000-4-2, test level 4 for both contact and air discharge. It also passes IEC61000-4-5, test level 3 for surge immunity.

If large ground potentials exist, optical isolation may be desired. One recommended optical isolator is B&B's Model 485OP, which provides 2 kV isolation. If most of the nodes in the network close together (limited ground differences), and one node is located at a distance (large ground difference), then a single optical isolator can be located on the distant node. If all of the nodes are distant from each other, optical isolation will be needed at every node.

The Model 485OP can also be used as a repeater to extend the network.

8.4 Termination

The RS-485 spec says to use termination. For high baud rates (>115k) and long cable runs, this is true.

In most equipment though, with maximum speeds of 115 kbit, it is unnecessary. Adding termination dramatically increases power consumption, and complicates system design. It rarely solves problems when used in the kilobit data range.

If power is not a concern, and signal integrity is questioned, the network can be terminated with a 120 ohm resistor at the extreme ends of the line. There should be no more than two terminations in a system that does not use repeaters.

8.5 Summary

- Use CABLE2TP-L 2-twisted-pair cable with shield and Santoprene jacket for most installations.
- Connect the MD485's ground lug to earth ground with an 8 AWG wire. This connection should be as short as possible.
- Connect the "signal ground" wire between MD485s.
- Ground the shield at one end only (to earth ground).

- In most instances, no termination is required.
- If large ground potentials exist, use optical isolation. (B&B's Model 4850P)
- Electrically, 256 MD485s can be connected, but that may be an unmanageable network.

Appendix A. Phone to MD485 Network

It is possible to access an MD485 network via telephone when the network is miles from the PC. See Figure A-1.

A Campbell Scientific Model COM220 Telephone Modem is used in conjunction with a Model PS100 Power Supply and A100 Null Modem Adapter to communicate with an MD485. The COM220 and the MD485 are both supplied with a 9 pin SC12 cable suitable for connection to the A100. The PS100 provides 5 and 12 volts for system operation and the A100 performs the function of a null modem (the COM220 and MD485 are both "modem" devices).

NOTE

The telephone to MD485 Network using a PS100 with A100 may be done with Transparent Communication or MD9 Emulation, but is not possible with PakBus Networking. Connection to a single PakBus Datalogger is still possible with Transparent Communication. PakBus Networking can be done by using a datalogger in place of the PS100/A100 for routing.

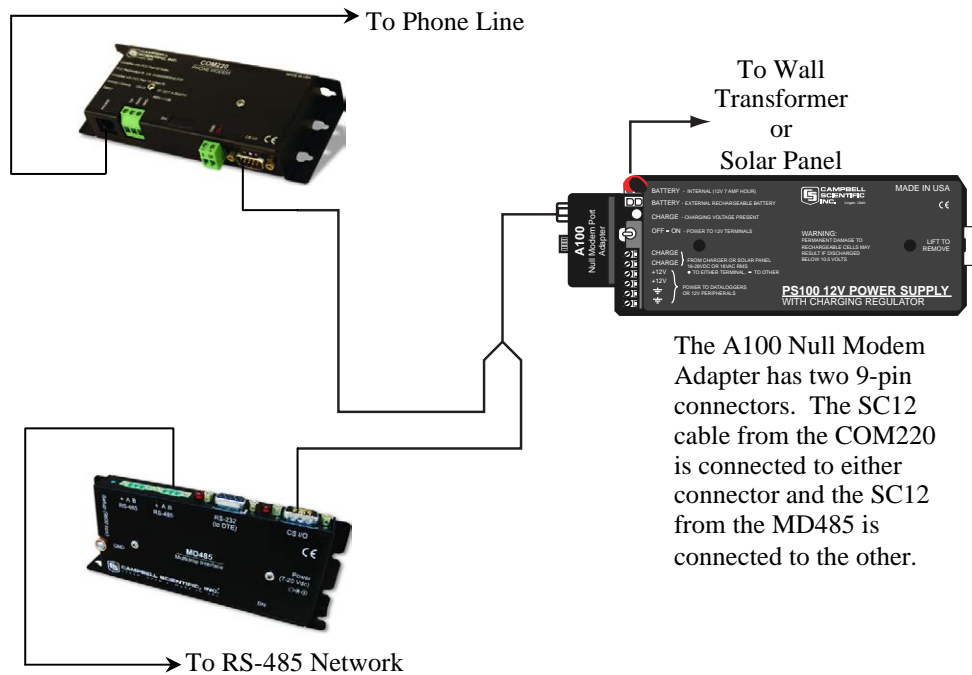

FIGURE A-1. Telephone to MD485 Conversion

Where a phone to MD485 Base is desired, the following configurations will provide Point-to-Point or Point-to-Multipoint communications.

1. HARDWARE REQUIREMENTS

- a. MD485s
- b. COM220
- c. PS100 with A100
- d. Transformer (CSI Item # 9591) or solar panel
- e. Three SC12 cables (one included with each MD485 and one with COM220)
- f. CABLE2TP cable

2. TRANSPARENT COMMUNICATION (POINT-TO-POINT)

PC-Modem---COM220-PS100 with A100-MD485---MD485-DL

LoggerNet Setup

- a. Setup:

ComPort_1
PhoneBase
PhoneRemote
PakBus Port (PakBus dataloggers only)
CR1000

- b. ComPort_1 – default settings
- c. PhoneBase
 - 1) Modem Type – specify PC's phone modem
 - 2) Maximum Baud Rate – 9600
 - 3) Extra Response Time – 0 s
- d. PhoneRemote – input base site's phone number
- e. PakBus Port – defaults
- f. CR1000 – default settings, schedule collections as desired

MD485 Configuration

- a. Base MD485
 - 1) Active Ports – “CS I/O and RS-485”
 - 2) Communication Mode – “Transparent Communication”
 - 3) CS I/O Port Configuration – “Modem to Modem w/o Datalogger”
 - 4) RS-485 Port Configuration – Desired baud rate
- b. Remote MD485
 - 1) Active Ports – “CS I/O and RS-485”
 - 2) Communication Mode – “Transparent Communication”
 - 3) CS I/O Port Configuration – Modem Enable
 - 4) RS-485 Port Configuration – Desired baud rate

3. MD9 EMULATION (POINT-TO-MULTIPOINT)

PC-Modem ---COM220-PS100 with A100-MD485 -----MD485-DL1
-----MD485-DL2

LoggerNet Setup

a. Setup:

ComPort_1
 PhoneBase
 PhoneRemote
 MD9Base
 MD9Remote
 CR10X
 MD9Remote_2
 CR10X_2

b. ComPort_1 – default settings

c. PhoneBase

- 1) Modem Type – specify PC's phone modem
- 2) Maximum Baud Rate – 9600
- 3) Extra Response Time – 0 s

d. PhoneRemote – input base site's phone number

e. MD9Base – defaults

f. MD9Remote – Address: “1”

g. MD9Remote_2 – Address: “2”

h. Dataloggers – default settings, schedule collections as desired

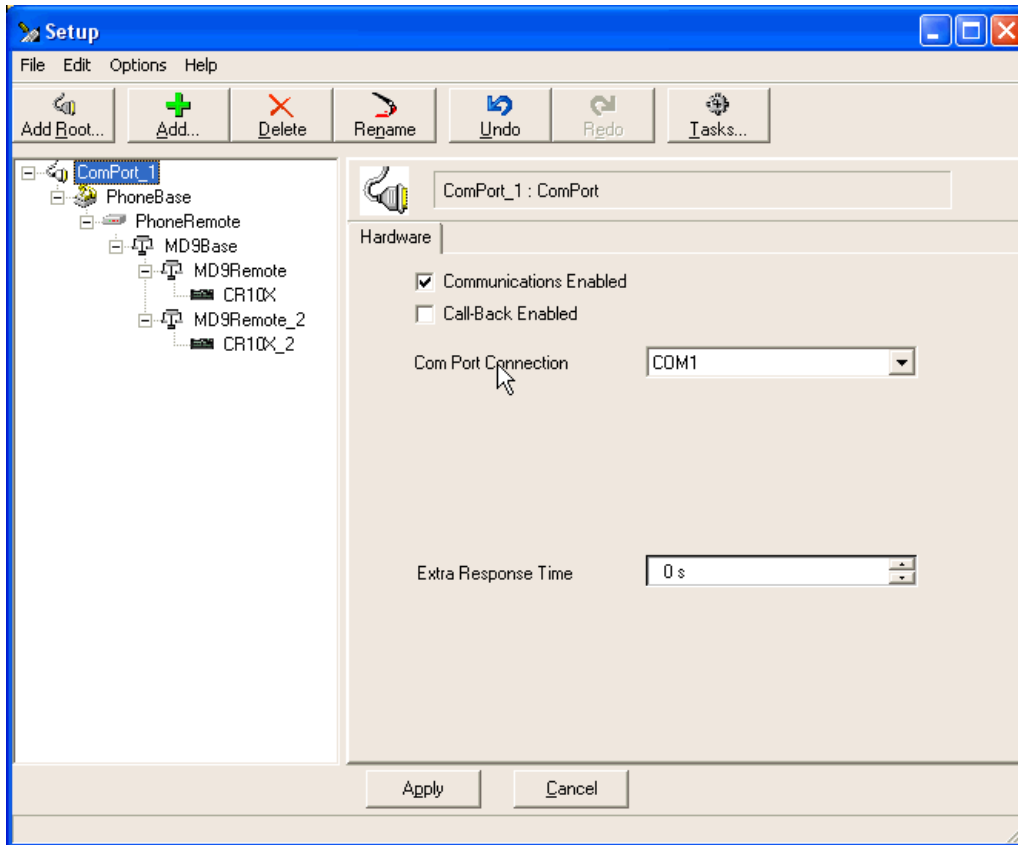

FIGURE A-2. LoggerNet Phone to MD485 MD9 Emulation Setup

MD485 Configuration

- a. Base MD485
 - 1) Active Ports – “CS I/O and RS-485”
 - 2) Communication Mode – “MD9 Emulation” with address 255
 - 3) CS I/O Port Configuration – “Modem to Modem w/o Datalogger”
 - 4) RS-485 Port Configuration – Desired baud rate
- b. Remote MD485s
 - 1) Active Ports – “CS I/O and RS-485”
 - 2) Communication Mode – “MD9 Emulation” with address 1, 2, etc. (unique for each remote MD485 and must agree with respective MD9 in device map)
 - 3) CS I/O Port Configuration – Modem Enable
 - 4) RS-485 Port Configuration – Desired baud rate

4. HARDWARE

After configuring LoggerNet or PC208W and the MD485s you are ready to set up hardware. The A100 null modem connectors (it’s not important which connector goes to which unit) connect via SC12 cables to the

COM220 and the base MD485 CS I/O port. Connect the site phone line to COM220. Connect power to PS100. When you turn on the PS100 supply, the MD485 receives 12V power and you will see the LEDs light in their power-up sequence.

Remote MD485s normally connect to datalogger CS I/O ports via SC12 cables. Powering up the datalogger will start the MD485 operating. Connect the CABLE2TP cable between the RS-485 ports of the base and remote MD485s and you are ready to connect to the datalogger.

Appendix B. RF401 to MD485 Network

Where an RF401 to MD485 network is desired, the following configurations will provide access to an MD485 network via RF401s.

The connection between the remote RF401 and the base MD485 can be made in two different ways. 1) Using a Campbell Scientific PS100 Power Supply with A100 Null Modem Adapter. The PS100 provides 5 and 12 volts for system operation and the A100 performs the function of a null modem (the RF401 and MD485 are both "modem" devices). 2) Using a null modem cable and transformers to provide power to the RF401 and the MD485.

The following sections will describe how to set-up the RF401 to MD485 network using each of these two methods for each communication mode.

B.1 Connection using a PS100 with A100

Figure B-1 shows an RF401 to MD485 network using a PS100 with A100. The following configurations will provide communications in transparent mode or with MD9 emulation. Connection to a single PakBus datalogger is possible with transparent communication. PakBus Networking is not possible using the PS100/A100, but can be done using a datalogger in place of the PS100/A100 for routing.

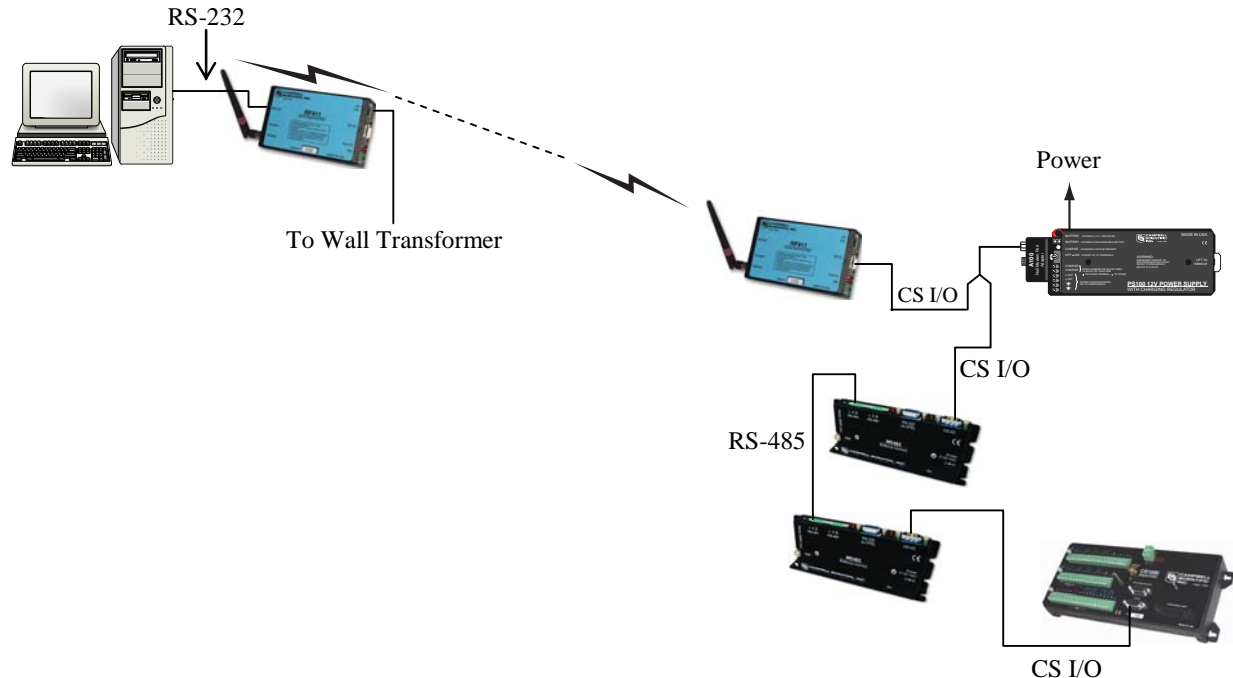

FIGURE B-1. RF401 to MD485 Conversion

1. HARDWARE REQUIREMENTS

- a. MD485s
- b. RF401s
- c. PS100 with A100
- d. Transformer (CSI Item #15966) for base RF401
- e. Transformer (CSI Item # 9591) or solar panel for PS100
- f. Three SC12 cables (one included with each MD485 and one with RF401)
- g. CABLE2TP

2. TRANSPARENT COMMUNICATION (POINT-TO-POINT)

PC-RF401----RF401-PS100 with A100-MD485---MD485-DL

LoggerNet Setup

- a. Setup:
 - ComPort_1
 - PakBus Port (PakBus dataloggers only)
 - CR1000
- b. ComPort_1 – default settings
- c. PakBus Port – defaults (PakBus dataloggers only)
- d. CR1000 – default settings, schedule collections as desired

MD485 Configuration

- a. Base MD485
 - 1) Active Ports – “CS I/O and RS-485”
 - 2) Communication Mode – “Transparent Communication”
 - 3) CS I/O Port Configuration – “Modem to Modem w/o Datalogger”
 - 4) RS-485 Port Configuration – Desired baud rate
- b. Remote MD485
 - 1) Active Ports – “CS I/O and RS-485”
 - 2) Communication Mode – “Transparent Communication”
 - 3) CS I/O Port Configuration – Modem Enable
 - 4) RS-485 Port Configuration – Desired baud rate

RF401 Configuration

The RF401s may be left in their default settings. However, if there is a neighboring RF401 network, you should change the Hopping Sequence of base and remote RF401s to a new setting to avoid interference.

3. MD9 EMULATION (POINT-TO-MULTIPOINT)

PC-RF401 ----RF401-PS100 with A100-MD485 -----MD485-DL1
 -----MD485-DL2

LoggerNet Setup

a. Setup:

ComPort_1
 MD9Base
 MD9Remote
 CR10X
 MD9Remote_2
 CR10X_2

b. ComPort_1 – default settings

c. MD9Base – defaults

d. MD9Remote – Address: “1“

e. MD9Remote_2 – Address: “2“

f. Dataloggers – default settings, schedule collections as desired

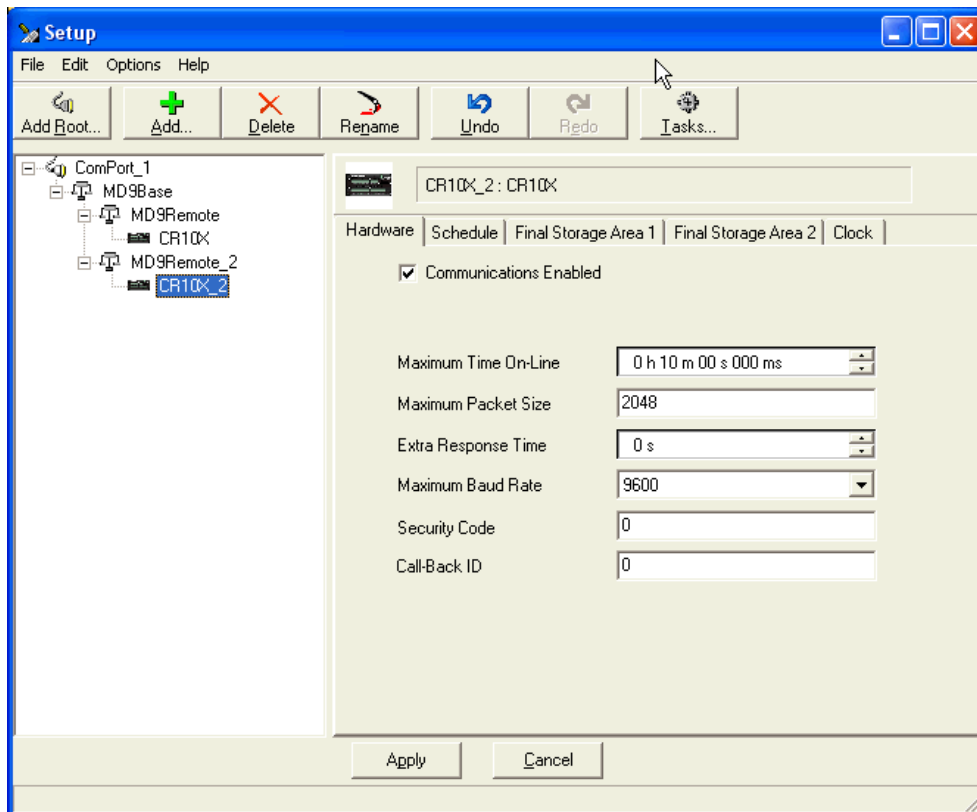

FIGURE B-2. LoggerNet RF401 to MD485 MD9 Emulation Setup

MD485 Configuration

- a. Base MD485
 - 1) Active Ports – “CS I/O and RS-485”
 - 2) Communication Mode – “MD9 Emulation” with address 255
 - 3) CS I/O Port Configuration – “Modem to Modem w/o Datalogger”
 - 4) RS-485 Port Configuration – Desired baud rate
- b. Remote MD485s
 - 1) Active Ports – “CS I/O and RS-485”
 - 2) Communication Mode – “MD9 Emulation” with address 1, 2, etc. (unique for each remote MD485 and must agree with respective MD9 in device map)
 - 3) CS I/O Port Configuration – Modem Enable
 - 4) RS-485 Port Configuration – Desired baud rate

RF401 Configuration

The RF401s may be left in their default settings. However, if there is a neighboring RF401 network, you should change the Hopping Sequence of base and remote RF401s to a new setting to avoid interference.

4. HARDWARE

After configuring LoggerNet or PC208W, the RF401s and the MD485s you are ready to set up hardware. Connect the base RF401 RS-232 port to the PC COM port. The A100 null modem connectors (it’s not important which connector goes to which unit) connect via SC12 cables to the CS I/O ports of the remote RF401 and the base MD485. Connect power to the PS100. When you turn on the PS100 supply, the MD485 receives 12V power and you will see the LEDs light in their power-up sequence.

Remote MD485s normally connect to datalogger CS I/O ports via SC12 cables. Powering up the datalogger will start the MD485 operating. Connect the CABLE2TP cable between the RS-485 ports of the base and remote MD485s and you are ready to connect to the datalogger.

B.2 Connection using a Null Modem Cable

The RF401 to MD485 conversion can be done using a null modem cable in place of the PS100/A100. The following configurations will provide communications in transparent mode, MD9 Emulation or PakBus Networking.

1. HARDWARE REQUIREMENTS

- a. MD485s
- b. RF401s
- c. Three transformers (CSI Item #15966)
- d. Null modem cable (CSI Item #18663)
- e. Three SC12 cables (one included with each MD485 and one with RF401)
- f. CABLE2TP

2. TRANSPARENT COMMUNICATION (POINT-TO-POINT)

PC-RF401----RF401--null modem--MD485---MD485-DL

LoggerNet Setup

- a. Setup:
 - ComPort_1
 - PakBus Port (PakBus dataloggers only)
 - CR1000
- b. ComPort_1 – default settings
- c. PakBus Port – defaults (PakBus dataloggers only)
- d. CR1000 – corresponding PakBus address (PakBus dataloggers only), other settings default, schedule collections as desired

MD485 Configuration

- a. Base MD485
 - 1) Active Ports – “RS-232 and RS-485”
 - 2) Communication Mode – “Transparent Communication”
 - 3) RS-232 Port Configuration – Desired baud rate
 - 4) RS-485 Port Configuration – Desired baud rate
- b. Remote MD485
 - 1) Active Ports – “CS I/O and RS-485”
 - 2) Communication Mode – “Transparent Communication”
 - 3) CS I/O Port Configuration – Modem Enable
 - 4) RS-485 Port Configuration – Desired baud rate

RF401 Configuration

The RF401s may be left in their default settings. However, if there is a neighboring RF401 network, you should change the Hopping Sequence of base and remote RF401s to a new setting to avoid interference.

3. MD9 EMULATION (POINT-TO-MULTIPOINT)

PC-RF401 ----RF401--null modem---MD485 -----MD485-DL1
 -----MD485-DL2

LoggerNet Setup

- a. Setup:
 - ComPort_1
 - MD9Base
 - MD9Remote
 - CR23X
 - MD9Remote_2
 - CR23X_2

- b. ComPort_1 – default settings
- c. MD9Base – defaults
- d. MD9Remote – Address: “1“
- e. MD9Remote_2 – Address: “2“
- f. Dataloggers – default settings, schedule collections as desired

MD485 Configuration

- a. Base MD485
 - 1) Active Ports – “RS-232 and RS-485”
 - 2) Communication Mode – “MD9 Emulation” with address 255
 - 3) RS-232 Port Configuration – Desired baud rate
 - 4) RS-485 Port Configuration – Desired baud rate
- b. Remote MD485s
 - 1) Active Ports – “CS I/O and RS-485”
 - 2) Communication Mode – “MD9 Emulation” with address 1, 2, etc. (unique for each remote MD485 and must agree with respective MD9 in device map)
 - 3) CS I/O Port Configuration – Modem Enable
 - 4) RS-485 Port Configuration – Desired baud rate

RF401 Configuration

The RF401s may be left in their default settings. However, if there is a neighboring RF401 network, you should change the Hopping Sequence of base and remote RF401s to a new setting to avoid interference.

4. PAKBUS NETWORKING

PC-RF401 ----RF401--null modem---MD485 -----MD485-DL1
-----MD485-DL2

LoggerNet Setup

- a. Setup:
 - ComPort_1
 - PakBus Port
 - CR1000
 - CR1000_2
- b. ComPort_1 – default settings
- c. PakBus Port – defaults
- d. Dataloggers – corresponding PakBus address, other setting default, schedule collections as desired

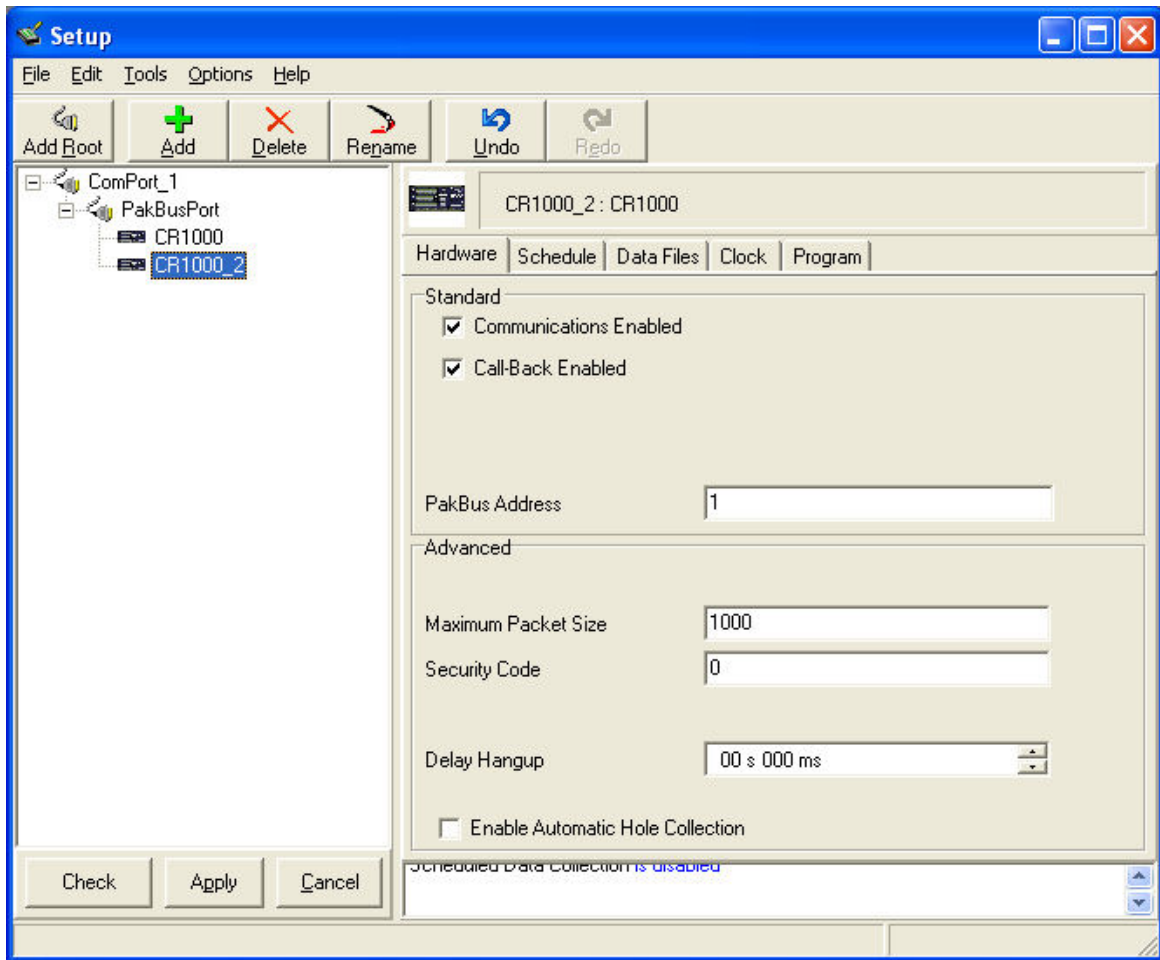

FIGURE B-3. LoggerNet PakBus Networking Setup

MD485 Configuration

a. Base MD485

- 1) Active Ports – “RS-232 and RS-485”
- 2) Communication Mode – “PakBus Networking”
- 3) RS-232 Port Configuration – Desired baud rate
- 4) RS-485 Port Configuration – Desired baud rate

b. Remote MD485s

- 1) Active Ports – “CS I/O and RS-485”
- 2) Communication Mode – “PakBus Networking”
- 3) CS I/O Port Configuration – SDC Address 7 or SDC Address 8
- 4) RS-485 Port Configuration – Desired baud rate

RF401 Configuration

The RF401s may be left in their default settings. However, if there is a neighboring RF401 network, you should change the Hopping Sequence of base and remote RF401s to a new setting to avoid interference.

5. HARDWARE

After configuring LoggerNet or PC208W, the RF401s and the MD485s you are ready to set up hardware. Connect the base RF401 RS-232 port to the PC COM port. Attach the null modem cable to the RS-232 ports of the remote RF401 and the base MD485. Attach transformers to the DC Pwr jack of each RF401 and the base MD485.

Remote MD485s normally connect to datalogger CS I/O ports via SC12 cables. Powering up the datalogger will start the MD485 operating. Connect the CABLE2TP cable between the RS-485 ports of the base and remote MD485s and you are ready to connect to the datalogger.

Appendix C. MD485 to RF401 Network

Where an MD485 to RF401 network is desired, the following configurations will provide access to an RF401 network via MD485s.

The connection between the remote MD485 and the base RF401 can be made in two different ways. 1) Using a Campbell Scientific PS100 Power Supply with A100 Null Modem Adapter. The PS100 provides 5 and 12 volts for system operation and the A100 performs the function of a null modem (the RF401 and MD485 are both "modem" devices). 2) Using a null modem cable and transformers to provide power to the RF401 and the MD485.

The following sections will describe how to set-up the MD485 to RF401 network using each of these two methods for each communication mode.

C.1 Connection using a PS100 with A100

Figure C-1 shows an MD485 to RF401 network using a PS100 with A100. The following configurations will provide communications in transparent mode or with MD9 emulation. Connection to a single PakBus datalogger is possible with transparent communication. PakBus Networking is not possible using the PS100/A100, but can be done using a datalogger in place of the PS100/A100 for routing.

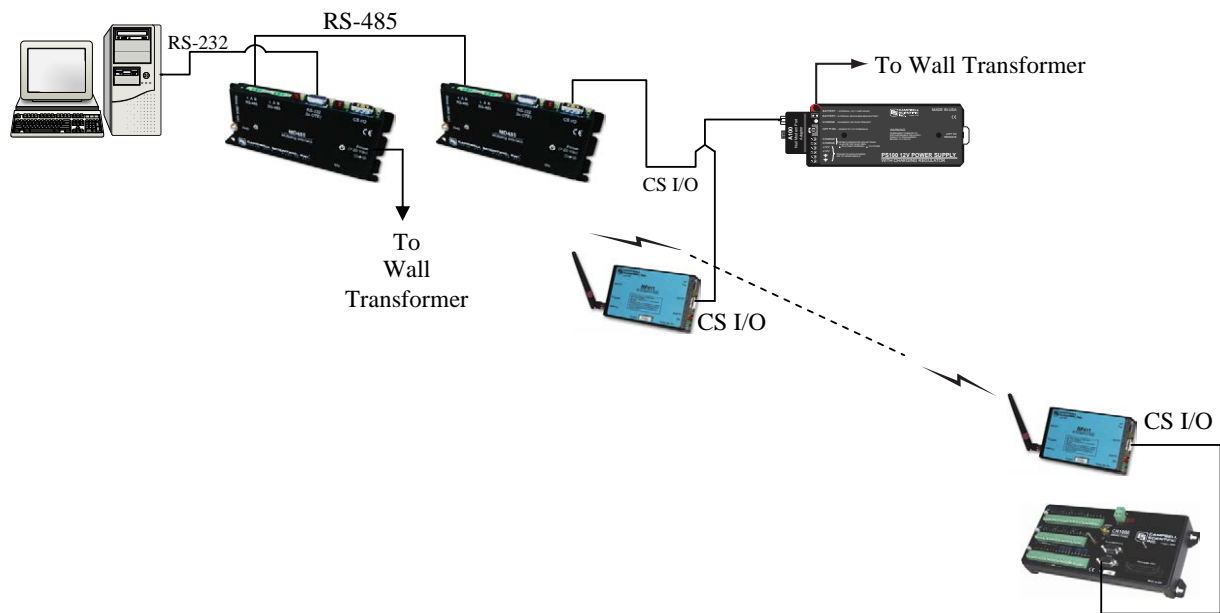

FIGURE C-1. MD485 to RF401 Conversion

1. HARDWARE REQUIREMENTS

- a. MD485s
- b. RF401s
- c. PS100 with A100
- d. Transformer (CSI Item #15966) for base MD485
- e. Transformer (CSI Item # 9591) or solar panel for PS100
- f. Three SC12 cables (one included with MD485 and one with each RF401)
- g. CABLE2TP cable

2. TRANSPARENT COMMUNICATION (POINT-TO-POINT)

PC-MD485----MD485-PS100 with A100-RF401---RF401-DL

LoggerNet Setup

- a. Setup:

ComPort_1
PakBus Port (PakBus dataloggers only)
CR1000

- b. ComPort_1 – default settings
- c. PakBus Port – defaults (PakBus dataloggers only)
- d. CR1000 – default settings, schedule collections as desired

MD485 Configuration

- a. Base MD485
 - 1) Active Ports – “RS-232 and RS-485”
 - 2) Communication Mode – “Transparent Communication”
 - 3) RS-232 Port Configuration – Desired baud rate
 - 4) RS-485 Port Configuration – Desired baud rate
- b. Remote MD485
 - 1) Active Ports – “CS I/O and RS-485”
 - 2) Communication Mode – “Transparent Communication”
 - 3) CS I/O Port Configuration – Modem Enable
 - 4) RS-485 Port Configuration – Desired baud rate

RF401 Configuration

The active interface of the base RF401 should be set to “COM2xx to RF401”. All other RF401 settings maybe left in their default state. However, if there is a neighboring RF401 network, you should change the Hopping Sequence of base and remote RF401s to a new setting to avoid interference.

3. MD9 EMULATION

PC-MD485---MD485-PS100 with A100-RF401---RF401-DL

LoggerNet Setup

a. Setup:

ComPort_1
 MD9Base
 MD9Remote
 CR10X

b. ComPort_1 – default settings

c. MD9Base – defaults

d. MD9Remote – Address: “1”

e. Datalogger – default settings, schedule collections as desired

MD485 Configuration

a. Base MD485

- 1) Active Ports – “RS-232 and RS-485”
- 2) Communication Mode – “MD9 Emulation” with address 255
- 3) RS-232 Port Configuration – Desired baud rate
- 4) RS-485 Port Configuration – Desired baud rate

b. Remote MD485

- 1) Active Ports – “CS I/O and RS-485”
- 2) Communication Mode – “MD9 Emulation” with address 1, 2, etc. (unique for each remote MD485 and must agree with respective MD9 in device map)
- 3) CS I/O Port Configuration – Modem Enable
- 4) RS-485 Port Configuration – Desired baud rate

RF401 Configuration

The active interface of the base RF401 should be set to “COM2xx to RF401”. All other RF401 settings may be left in their default state. However, if there is a neighboring RF401 network, you should change the Hopping Sequence of base and remote RF401s to a new setting to avoid interference.

4. HARDWARE

After configuring LoggerNet or PC208W, the RF401s and the MD485s you are ready to set up hardware. Connect the base MD485 RS-232 port to the PC COM port. Attach a transformer to the DC Pwr jack of the base MD485. The A100 null modem connectors (it’s not important which connector goes to which unit) connect via SC12 cables to the CS I/O ports of the remote MD485 and the base RF401. Connect power to the PS100.

When you turn on the PS100 supply, the MD485 and the RF401 receive 12V power and you will see the LEDs light in their power-up sequence.

The remote RF401 connects to datalogger CS I/O port via an SC12 cable. Powering up the datalogger will start the RF401 operating.

Connect the two twisted pair, shielded cable between the RS-485 ports of the base and remote MD485s and you are ready to connect to the datalogger.

C.2 Connection using a Null Modem Cable

The MD485 to RF401 conversion can be done using a null modem cable in place of the PS100/A100. The following configurations will provide communications in transparent mode, MD9 Emulation or PakBus Networking.

1. HARDWARE REQUIREMENTS

- a. MD485s
- b. RF401s
- c. Three transformers (CSI Item #15966)
- d. Null modem cable (CSI Item #18663)
- e. Three SC12 cables (one included with each RF401 and one with MD485)
- f. CABLE2TP cable

2. TRANSPARENT COMMUNICATION (POINT-TO-POINT)

PC-MD485----MD485--null modem--RF401---RF401-DL

LoggerNet Setup

- a. Setup:
 - ComPort_1
 - PakBus Port (PakBus dataloggers only)
 - CR1000
- b. ComPort_1 – default settings
- c. PakBus Port – defaults (PakBus dataloggers only)
- d. CR1000 – default settings, schedule collections as desired

MD485 Configuration

- a. Base MD485
 - 1) Active Ports – “RS-232 and RS-485”
 - 2) Communication Mode – “Transparent Communication”
 - 3) RS-232 Port Configuration – Desired baud rate
 - 4) RS-485 Port Configuration – Desired baud rate

- b. Remote MD485
 - 1) Active Ports – “RS-232 and RS-485”
 - 2) Communication Mode – “Transparent Communication”
 - 3) RS-232 Port Configuration – Desired baud rate
 - 4) RS-485 Port Configuration – Desired baud rate

RF401 Configuration

The RF401s may be left in their default settings. However, if there is a neighboring RF401 network, you should change the Hopping Sequence of base and remote RF401s to a new setting to avoid interference.

3. MD9 EMULATION (POINT-TO-MULTIPOINT)

PC-MD485----MD485--null modem---RF401--RF401-DL

LoggerNet Setup

- a. Setup:
 - ComPort_1
 - MD9Base
 - MD9Remote
 - CR23X
- b. ComPort_1 – default settings
- c. MD9Base – defaults
- d. MD9Remote – Address: “1”
- e. Dataloggers – default settings, schedule collections as desired

MD485 Configuration

- a. Base MD485
 - 1) Active Ports – “RS-232 and RS-485”
 - 2) Communication Mode – “MD9 Emulation” with address 255
 - 3) RS-232 Port Configuration – Desired baud rate
 - 4) RS-485 Port Configuration – Desired baud rate
- b. Remote MD485s
 - 1) Active Ports – “RS-232 and RS-485”
 - 2) Communication Mode – “MD9 Emulation” with address 1, 2, etc. (unique for each remote MD485 and must agree with respective MD9 in device map)
 - 3) RS-232 Port Configuration – Desired baud rate
 - 4) RS-485 Port Configuration – Desired baud rate

RF401 Configuration

The RF401s may be left in their default settings. However, if there is a neighboring RF401 network, you should change the Hopping Sequence of base and remote RF401s to a new setting to avoid interference.

NOTE

When using MD9 Emulation, after disconnecting from a datalogger, you must wait for a 40-second timeout before being able to connect again.

4. PAKBUS NETWORKING

PC-MD485---MD485--null modem---RF401---RF401-DL

LoggerNet Setup

a. Setup:

ComPort_1
PakBus Port
CR1000

b. ComPort_1 – default settings

c. PakBus Port – defaults

d. Dataloggers – corresponding PakBus address, other setting default, schedule collections as desired

MD485 Configuration

a. Base MD485

- 1) Active Ports – “RS-232 and RS-485”
- 2) Communication Mode – “PakBus Networking”
- 3) RS-232 Port Configuration – Desired baud rate
- 4) RS-485 Port Configuration – Desired baud rate

b. Remote MD485s

- 1) Active Ports – “RS-232 and RS-485”
- 2) Communication Mode – “PakBus Networking”
- 3) RS-232 Port Configuration – Desired baud rate
- 4) RS-485 Port Configuration – Desired baud rate

RF401 Configuration

The RF401s may be left in their default settings. However, if there is a neighboring RF401 network, you should change the Hopping Sequence of base and remote RF401s to a new setting to avoid interference.

4. **HARDWARE**

After configuring LoggerNet or PC208W, the RF401s and the MD485s you are ready to set up hardware. Connect the base MD485 RS-232 port to the PC COM port. Attach the null modem cable to the RS-232 ports of the remote MD485 and the base RF401. Attach transformers to the DC Pwr jack of each MD485 and the base RF401.

Remote RF401s normally connect to datalogger CS I/O ports via SC12 cables. Powering up the datalogger will start the RF401 operating.

Connect the CABLE2TP cable between the RS-485 ports of the base and remote MD485s and you are ready to connect to the datalogger.

Appendix D. Digital Cellular Modem to MD485 Network

It is possible to access an MD485 network via a digital cellular modem when the network is miles from the PC (see Figure D-1). Although hardware requirements are similar, the LoggerNet setup for our RavenXT-series, Raven100, and Raven110 digital cellular modems is different than the LoggerNet setup for the Redwing100 and Redwing105 digital cellular modems.

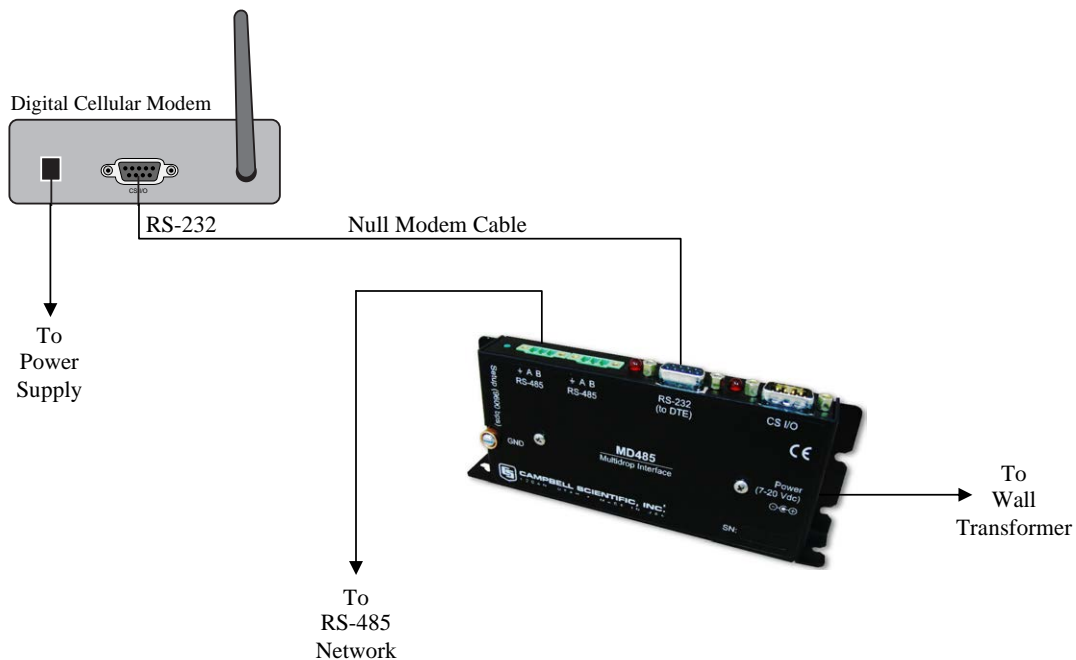

FIGURE D-1. Digital Cellular Modem to MD485 Conversion

D.1 RavenXT-series, Raven100, and Raven110 Digital Cellular Modems

Where a RavenXT-series, Raven100, or Raven110 digital cellular modem to MD485 base is desired, the following configurations will provide communications in transparent mode, with MD9 Emulation or PakBus Networking.

1. HARDWARE REQUIREMENTS

- a. MD485s
- b. RavenXT-series, Raven100, or Raven110 digital cellular modem
- c. Transformer (CSI Item #15966)
- d. Null modem cable (CSI Item #18663)
- e. SC12 cables (one included with each MD485)
- f. CABLE2TP cable

2. TRANSPARENT COMMUNICATION (POINT-TO-POINT)

PC---Cell Tower--Raven---null modem---MD485---MD485-DL

LoggerNet Setup

a. Setup

IPPort

PakBusPort (PakBus dataloggers only)

CR1000

b. IPPort – Internet IP address/domain name and the Port number (the Raven template file configures the port to be 3001).

c. PakBus Port—defaults

d. CR1000 – default settings, schedule collections as desired

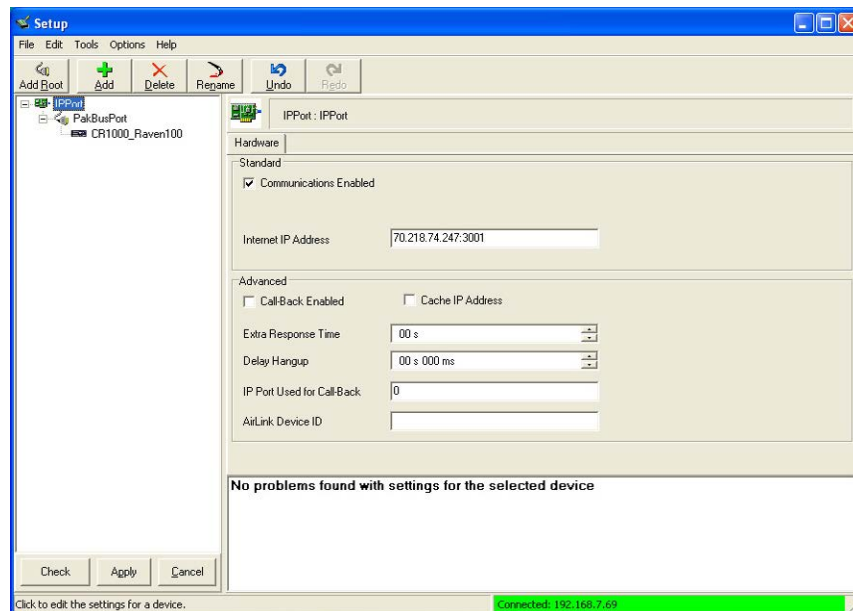

MD485 Configuration

a. Base MD485

- 1) Active Ports – “RS-232 and RS-485”
- 2) Communication Mode – “Transparent Communications”
- 3) RS-232 Port Configuration – Desired baud rate
- 4) RS-485 Port Configuration – Desired baud rate

b. Remote MD485

- 1) Active Ports – “CS I/O and RS-485”
- 2) Communication Mode – “Transparent Communications”
- 3) CS I/O Port Configuration – Modem Enable
- 4) RS-485 Port Configuration – Desired baud rate

3. MD9 EMULATION (POINT-TO-MULTIPOINT)

PC---Cell Tower--Raven---null modem---MD485----MD485-DL1
----- MD485-DL2

LoggerNet Setup

a. Setup

IPPort
MD9Base
MD9Remote
CR10X
MD9Remote_2
CR10X_2

- b. IPPort – Internet IP address/domain name and the Port number (the Raven template file configures the port to be 3001).
- c. MD9Base —defaults
- d. MD9Remotes – appropriate addresses
- e. Dataloggers – default settings, schedule collections as desired

MD485 Configuration

a. Base MD485

- 1) Active Ports – “RS-232 and RS-485”
- 2) Communication Mode – “MD9 Emulation” with address 255
- 3) RS-232 Port Configuration – Desired baud rate
- 4) RS-485 Port Configuration – Desired baud rate

b. Remote MD485

- 1) Active Ports – “CS I/O and RS-485”
- 2) Communication Mode – “MD9 Emulation” with address 1, 2, etc (unique for each remote MD485 and must agree with respective MD9 in device map)
- 3) CS I/O Port Configuration – Modem Enable
- 4) RS-485 Port Configuration – Desired baud rate

4. PAKBUS NETWORKING

PC---Cell Tower--Raven---null modem---MD485----MD485-DL1
----- MD485-DL2

LoggerNet Setup

a. Setup

IPPort
PakBusPort
CR1000
CR1000_2

- b. IPPort – Internet IP address/domain name and the Port number (the Raven template file configures the port to be 3001).
- c. PakBus Port—defaults
- d. Dataloggers – corresponding PakBus address, other setting defaults, schedule collections as desired

MD485 Configuration

- a. Base MD485
 - 1) Active Ports – “RS-232 and RS-485”
 - 2) Communication Mode – “PakBus Networking”
 - 3) RS-232 Port Configuration – Desired baud rate
 - 4) RS-485 Port Configuration – Desired baud rate
- b. Remote MD485
 - 1) Active Ports – “CS I/O and RS-485”
 - 2) Communication Mode – “PakBus Networking”
 - 3) CS I/O Port Configuration – SDC Address 7 or SDC Address 8
 - 4) RS-485 Port Configuration – Desired baud rate

5. HARDWARE

After configuring LoggerNet or PC208W and the DM485s, you are ready to set up hardware. Attach the null modem cable to the RS-232 ports of the digital cellular modem and the base MD485. Attach the wall transformer to the DC Pwr jack of the base MD485.

Remote MD485s normally connect to datalogger CS I/O ports via SC12 cables. Powering up the datalogger will start the MD485 operating. Connect the CABLE2TP cable between the RS-485 ports of the base and remote MD485 s and you are ready to connect to the datalogger.

D.2 Redwing100 and Redwing105 Digital Cellular Modems

Where a Redwing100 or Redwing105 digital cellular modem to MD485 Base is desired, the following configurations will provide communications in transparent mode, with MD9 Emulation or PakBus Networking.

1. HARDWARE REQUIREMENTS

- a. MD485s
- b. Redwing100 or Redwing105 CDMA modem
- c. Transformer (CSI Item #15966)
- d. Null modem cable (CSI Item #18663)
- e. SC12 cables (one included with each MD485)
- f. CABLE2TP cable

2. TRANSPARENT COMMUNICATION

PC-Modem---Cell Tower Redwing-null modem-MD485-MD485-DL

LoggerNet Setup

a. Setup:

- TAPIPort
- TAPIRemote
- PakBus Port (PakBus dataloggers only)
- CR1000

- b. TAPIPort – TAPI line corresponding to PC's modem
- c. TAPIRemote – input digital cellular modem's phone number
- d. PakBus Port – defaults (PakBus dataloggers only)
- e. CR1000 – default settings, schedule collections as desired

MD485 Configuration

a. Base MD485

- 1) Active Ports – “RS-232 and RS-485”
- 2) Communication Mode – “Transparent Communication”
- 3) RS-232 Port Configuration – Desired baud rate
- 4) RS-485 Port Configuration – Desired baud rate

b. Remote MD485

- 1) Active Ports – “CS I/O and RS-485”
- 2) Communication Mode – “Transparent Communication”
- 3) CS I/O Port Configuration – Modem Enable
- 4) RS-485 Port Configuration – Desired baud rate

3. MD9 EMULATION (POINT-TO-MULTIPOINT)

PC-Modem---Cell Tower Redwing-null modem cable-MD485 -----MD485-DL1
-----MD485-DL2

LoggerNet Setup

a. Setup:

- TAPIPort
- TAPIRemote
- MD9Base
- MD9Remote
- CR10X
- MD9Remote_2
- CR10X_2

- b. TAPIPort – TAPI line corresponding to PC's modem

- c. TAPIRemote – input digital cellular modem's phone number
- d. MD9Base – defaults
- e. MD9Remote – Address: “1”
- f. MD9Remote_2 – Address: “2”
- g. Dataloggers – default settings, schedule collections as desired

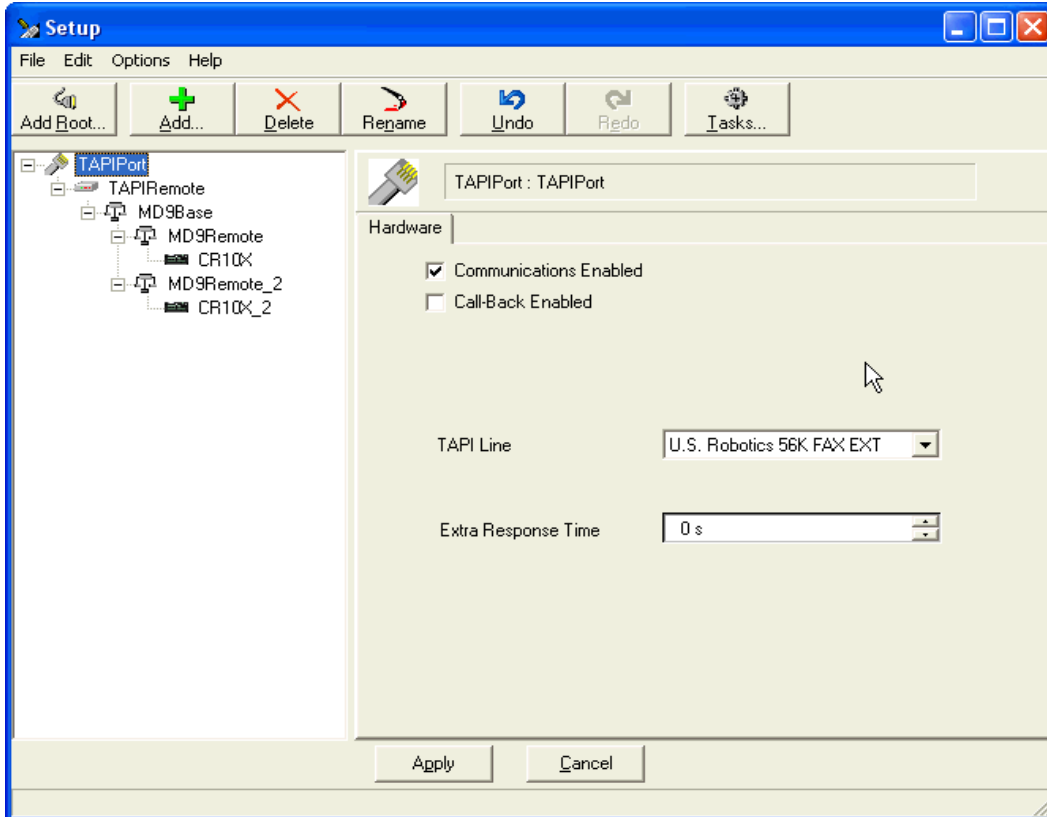

FIGURE D-2. LoggerNet Digital Cellular Modem to MD485 MD9 Emulation Setup

MD485 Configuration

- a. Base MD485
 - 1) Active Ports – “RS-232 and RS-485”
 - 2) Communication Mode – “MD9 Emulation” with address 255
 - 3) RS-232 Port Configuration – Desired baud rate
 - 4) RS-485 Port Configuration – Desired baud rate

- b. Remote MD485s
 - 1) Active Ports – “CS I/O and RS-485”
 - 2) Communication Mode – “MD9 Emulation” with address 1, 2, etc. (unique for each remote MD485 and must agree with respective MD9 in device map)
 - 3) CS I/O Port Configuration – Modem Enable
 - 4) RS-485 Port Configuration – Desired baud rate

4. PAKBUS NETWORKING

PC-Modem ---Redwing--null modem---MD485 -----MD485-DL1
-----MD485-DL2

LoggerNet SETUP

- a. Setup:
 - TAPIPort
 - TAPIRemote
 - PakBus Port
 - CR1000
 - CR1000_2
- b. TAPIPort – TAPI line corresponding to PC's modem
- c. TAPIRemote – input digital cellular modem's phone number
- d. PakBus Port – defaults
- e. Dataloggers – corresponding PakBus address, other setting default, schedule collections as desired

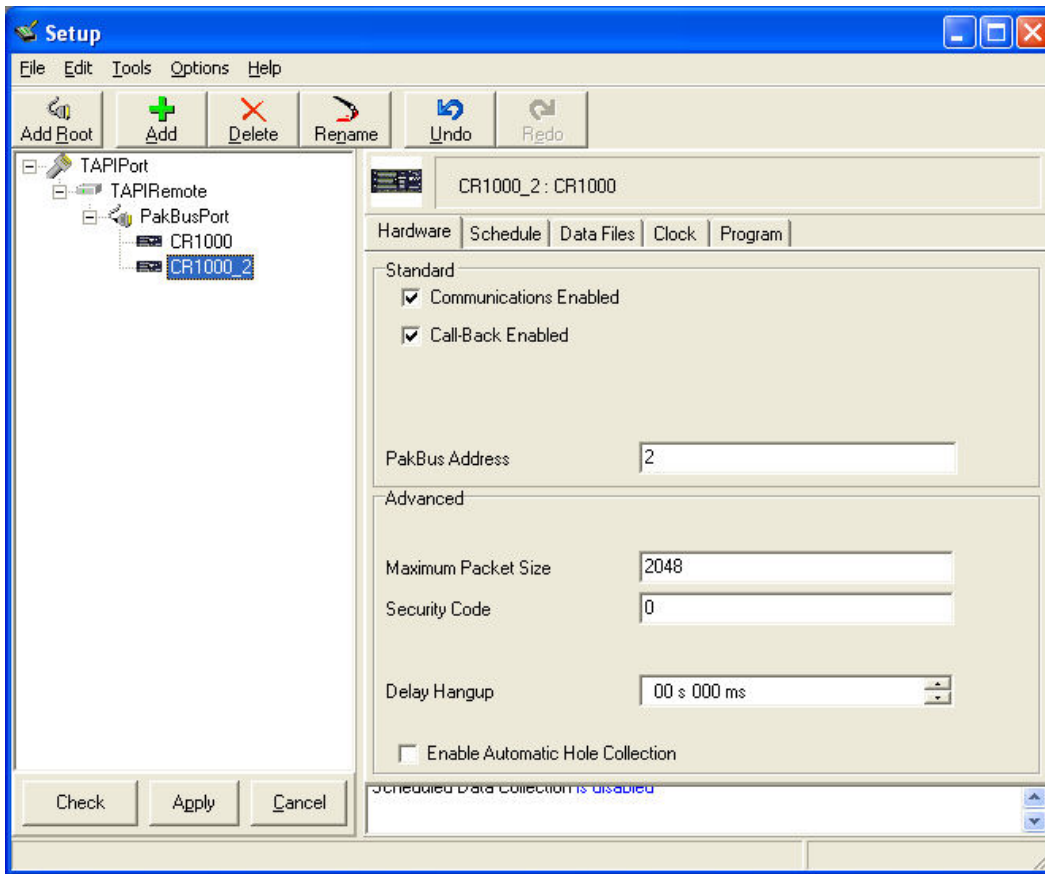

FIGURE D-3. LoggerNet Digital Cellular Modem to MD485 PakBus Networking Setup

MD485 CONFIGURATION

a. Base MD485

- 1) Active Ports – “RS-232 and RS-485”
- 2) Communication Mode – “PakBus Networking”
- 3) RS-232 Port Configuration – Desired baud rate
- 4) RS-485 Port Configuration – Desired baud rate

b. Remote MD485s

- 1) Active Ports – “CS I/O and RS-485”
- 2) Communication Mode – “PakBus Networking”
- 3) CS I/O Port Configuration – SDC Address 7 or SDC Address 8
- 4) RS-485 Port Configuration – Desired baud rate

5. HARDWARE

After configuring LoggerNet or PC208W and the MD485s you are ready to set up hardware. Attach the null modem cable to the RS-232 ports of the digital cellular modem and the base MD485. Attach wall transformers to the DC Pwr jack of the base MD485 and the digital cellular modem.

Remote MD485s normally connect to datalogger CS I/O ports via SC12 cables. Powering up the datalogger will start the MD485 operating. Connect the CABLE2TP cable between the RS-485 ports of the base and remote MD485s and you are ready to connect to the datalogger.

Appendix E. NL100 to MD485 Network

It is possible to access an MD485 network via a TCP/IP network using an NL100. See Figure E-1.

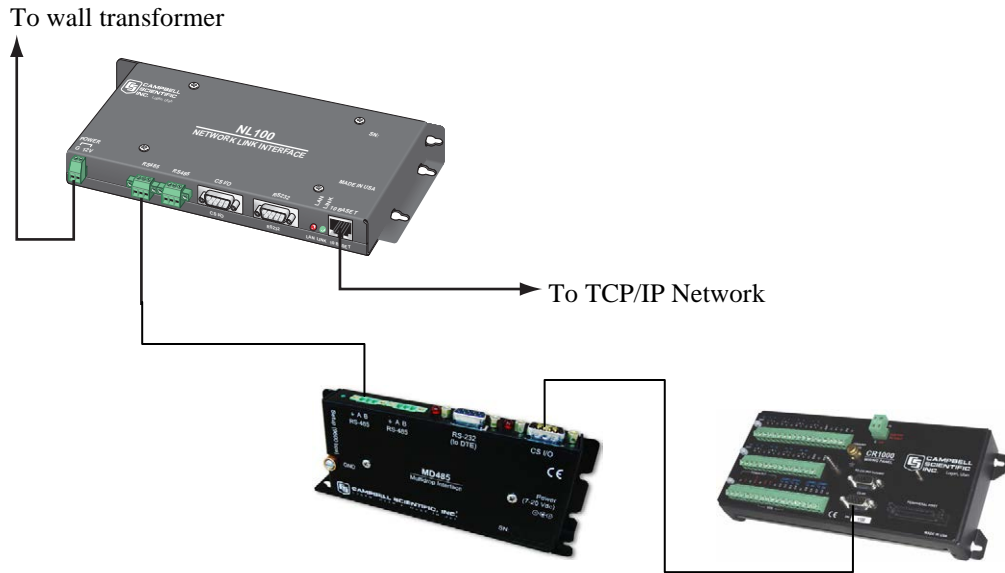

FIGURE E-1. NL100 to MD485 Conversion

Where an NL100 to MD485 network is desired, the following configurations will provide communications in transparent mode, with MD9 emulation or with PakBus Networking. The NL100 does not perform MD9 emulation. So at least two MD485s are always required for MD9 emulation with an NL100.

1. HARDWARE REQUIREMENTS

- a. MD485(s)
- b. NL100
- c. NL100 Transformer (CSI Item #13947) or other source of power for NL100
- d. Ethernet Cable
- e. SC12 cable(s) (one included with each MD485)
- f. CABLE2TP cable

2. TRANSPARENT COMMUNICATION (POINT-TO-POINT)

PC-----NL100---MD485-DL

LoggerNet Setup

- a. Setup:
 - IPPort
 - PakBus Port (PakBus dataloggers only)
 - CR1000

- b. IP Port – Internet IP Address – NL100 IP address : NL100 RS-485 serial server port number. (The NL100 RS-485 serial server port number is configured using the NL100 configuration menu.)
- c. PakBus Port – defaults (PakBus dataloggers only)
- d. CR1000 – default settings, schedule collections as desired

MD485 Configuration

- 1) Active Ports – “CS I/O and RS-485”
- 2) Communication Mode – “Transparent Communication”
- 3) CS I/O Port Configuration – Modem Enable
- 4) RS-485 Port Configuration – Desired baud rate

NL100 Configuration

- 1) RS-485 config – “TcpSer”
- 2) RS-485 bps – Desired baud rate
- 3) RS-485 serial server port number – May be left at default, but must match what is entered in LoggerNet Setup
- 4) Ethernet 10BaseT – “enabled”
- 5) 10BaseT port IP address – NL100 IP address
- 6) 10BaseT port network mask– NL100 network mask

The other NL100 options can be left in their default state.

3. MD9 EMULATION

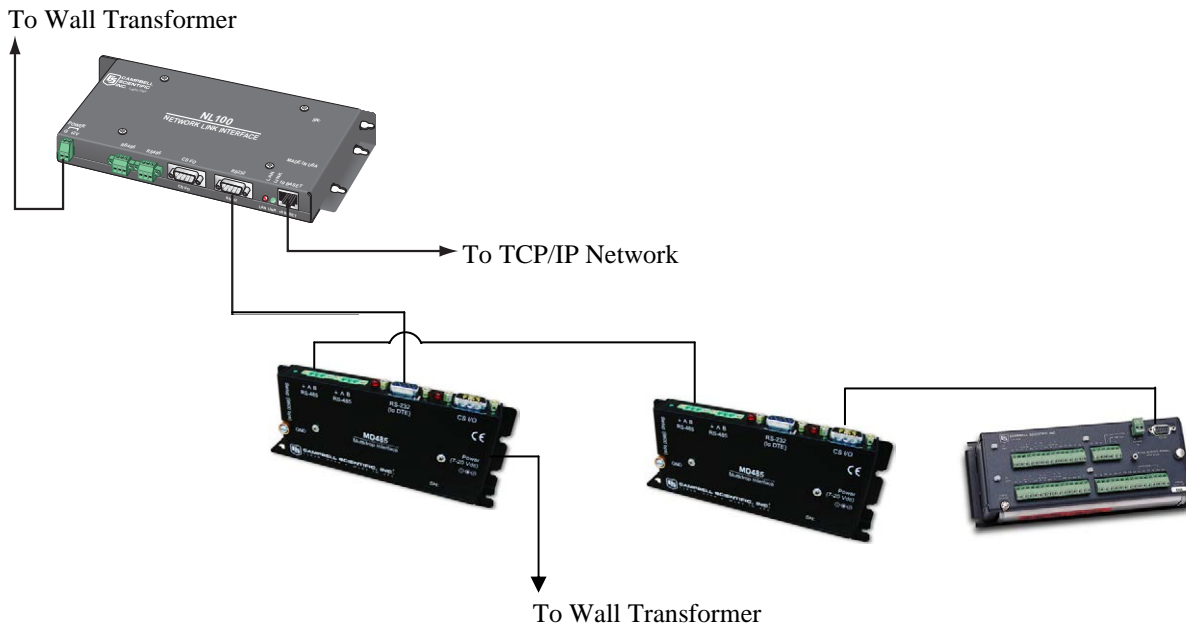

FIGURE E-2. NL100 to MD485 Conversion for MD9 Emulation

PC -----NL100-----MD485 -----MD485-DL1
-----MD485-DL2

LoggerNet Setup

- a. Setup:

IPPort
MD9Base
MD9Remote
CR10X
MD9Remote_2
CR10X_2

- b. IPPort – Internet IP Address – NL100 IP address : RS-232 serial port number.

(The RS-232 serial port number is configured using the NL100 configuration menu.)

- c. MD9Base – defaults
d. MD9Remotes – appropriate addresses
e. Dataloggers – default settings, schedule collections as desired

Base MD485 Configuration

- 1) Active Ports – “RS-232 and RS-485”
- 2) Communication Mode – “MD9 Emulation” with address 255
- 3) RS-232 Port Configuration – Desired baud rate
- 4) RS-485 Port Configuration – Desired baud rate

Remote MD485s

- 1) Active Ports – “CS I/O and RS-485”
- 2) Communication Mode – “MD9 Emulation” with address 1, 2, etc. (unique for each remote MD485 and must agree with respective MD9 in device map)
- 3) CS I/O Port Configuration – Modem Enable
- 4) RS-485 Port Configuration – Desired baud rate

NL100 Configuration

- 1) RS-232 config – “TcpSer”
- 2) RS-232 bps – Desired baud rate
- 3) RS-232 serial server port number – may be left at default, but must match what is entered in LoggerNet setup.
- 4) Ethernet 10BaseT – “enabled”
- 5) 10BaseT port IP address – NL100 IP address
- 6) 10BaseT port network mask– NL100 network mask

The other NL100 options can be left in their default state.

4. PAKBUS NETWORKING

PC-----NL100 -----MD485-DL1
-----MD485-DL2

LoggerNet Setup

- a. Setup:

IPPort
PakBus Port
CR1000
CR1000_2

- b. IPPort – Internet IP Address – NL100 IP address : NL100
PakBus/TCP server port number.

(In Figure E-3 123.45.6.789 represents the NL100 IP address and 6781 is the NL100 PakBus/TCP server port number. The NL100 PakBus/TCP server port number is configured using the NL100 configuration menu.)

- c. PakBus Port – defaults
- d. Dataloggers – corresponding PakBus address, other setting default, schedule collections as desired

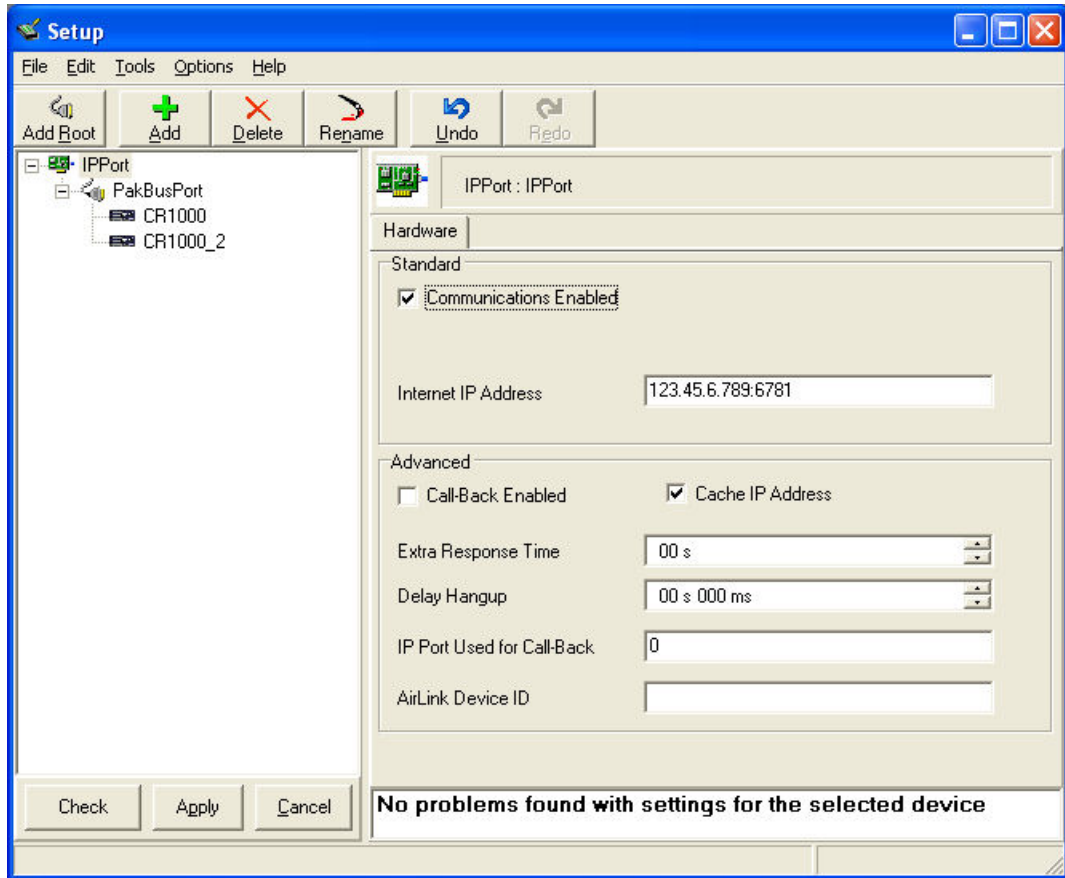

FIGURE E-3. LoggerNet NL100 to MD485 PakBus Networking Setup

MD485 Configuration

- 5) Active Ports – “CS I/O and RS-485”
- 6) Communication Mode – “PakBus Networking”
- 7) CS I/O Port Configuration – SDC7 or SDC8
- 8) RS-485 Port Configuration – Desired baud rate

NL100 Configuration

- 7) RS-485 config – “PakBus”
- 8) RS-485 bps – Desired baud rate
- 9) RS-485 beacon interval – 60
- 10) Ethernet 10aseT – “enabled”
- 11) 10BaseT port IP address – NL100 IP address
- 12) 10aseT port network mask– NL100 network mask
- 13) PakBus/TCP server config – “enabled”
- 14) PakBus/TCP server port number – May be left at default, but must match what is entered in LoggerNet Setup

The other NL100 options can be left in their default state.

5. HARDWARE

After configuring LoggerNet or PC208W, the NL100 and the MD485(s), you are ready to set up hardware. Attach the Ethernet cable to the 10BaseT port of the NL100. Supply power to the NL100.

The remote MD485(s) connect to datalogger CS I/O ports via SC12 cables. Powering up the datalogger(s) will start the MD485(s) operating. For transparent communication or PakBus networking, connect the CABLE2TP cable between the RS-485 ports of the NL100 and the MD485(s) and you are ready to connect to the datalogger(s). For MD9 emulation, connect the RS-232 port of the NL100 to the RS-232 port of the base MD485. Connect the CABLE2TP cable between the RS-485 ports of all MD485(s).

Appendix F. MD485 to CC640 Digital Camera

The MD485 is used with the CC640 Digital Camera when the distance between the datalogger is greater than 25 ft. MD485 to CC640 communications is only supported with PakBus networking.

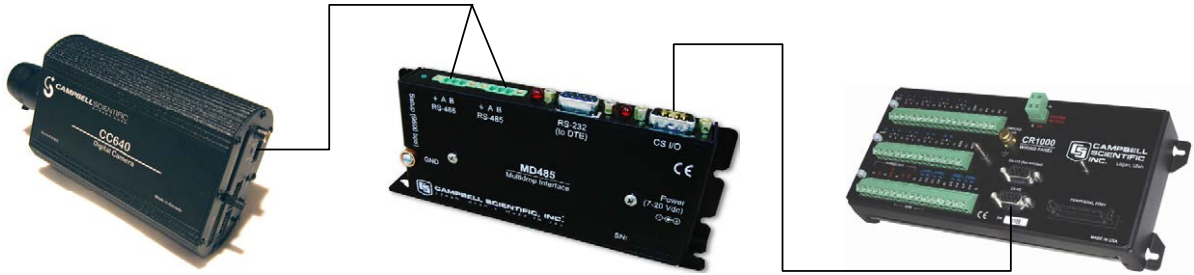

FIGURE F-1. Camera to MD485 Connection

Hardware Requirements

- MD485
- CC640 Digital Camera
- SC12 cable (one included with each MD485)
- CABLE5CBL-L 5-conductor cable with shield and Santoprene jacket

MD485 Configuration

- Active Ports – CS I/O and RS-485
- Communication Mode – PakBus Networking
- CS I/O Port Configuration – SDC7 or SDC8
- RS-485 Port Configuration – Desired baud rate

CC640 Configuration

The camera is configured using DevConfig.

- PakBus Port – RS-485
- PakBus Address – set to a unique value in the PakBus network
- PakBus Destination Address – the datalogger’s PakBus address
- RS-485 BAUD rate – this baud rate must match the MD485’s baud rate

All other parameters may use the defaults (see CC640 manual for more information).

Hardware

The MD485 connects to the datalogger via the SC12 cable. Connect the CABLE5CBL 5-conductor cable to the RS-485 port on the MD485. Connect the other end of the CABLE5CBL cable to the terminal block on the camera.

Appendix G. MD485 to AVW200 Interface

The MD485 is used with the AVW200 Interface for situations where wireless communication is impractical and the distance between the AVW200 interfaces needs to be extended. MD485 to AVW200 communications is only supported with PakBus networking.

Both point-to-point and point-to-multipoint configurations are possible. The point-to-point configuration is the simplest MD485-to-AVW200 network. In this configuration, two MD485s are required (see Figure G-1).

The point-to-multipoint configuration uses several AVW200s. In this configuration, you need one MD485 to connect with the datalogger and another MD485 for each AVW200 in the network. Each AVW200 must have a unique PakBus address.

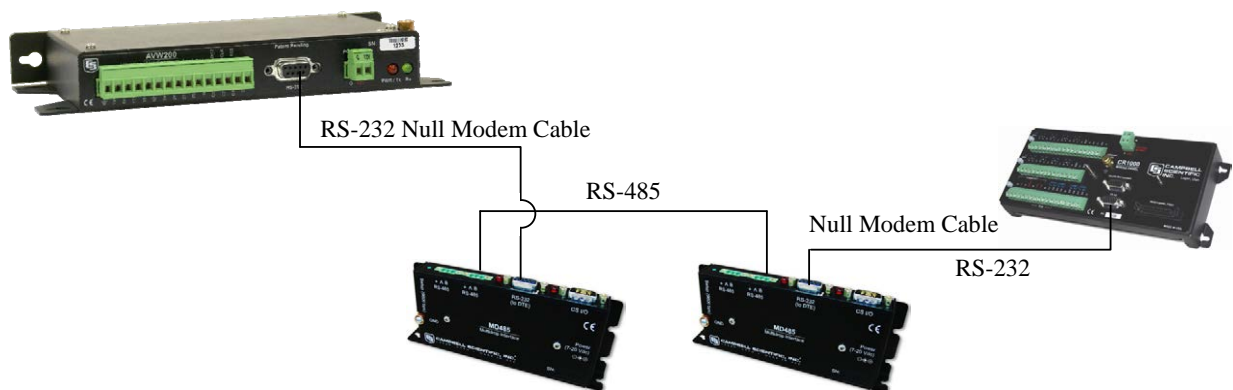

FIGURE G-1. MD485 to AVW200 Connection (point-to-point)

Hardware Requirements

- a. MD485s
- b. AVW200(s)
- c. Null Modem Cables (CSI Item #18663); one null modem cable connects the MD485 to the datalogger; another null modem cable is required for each AVW200 in the network
- d. CABLE2TP 2-twisted-pair cable with shield and Santoprene Jacket

MD485 Configuration

Each MD485 in the network must be configured with the following settings (see Figure G-2):

- a. Active Ports – RS-232 and RS-485
- b. Communication Mode – PakBus Networking
- c. RS-232 Baud Rate – 38.4k
- d. RS-485 Baud Rate – 38.4k

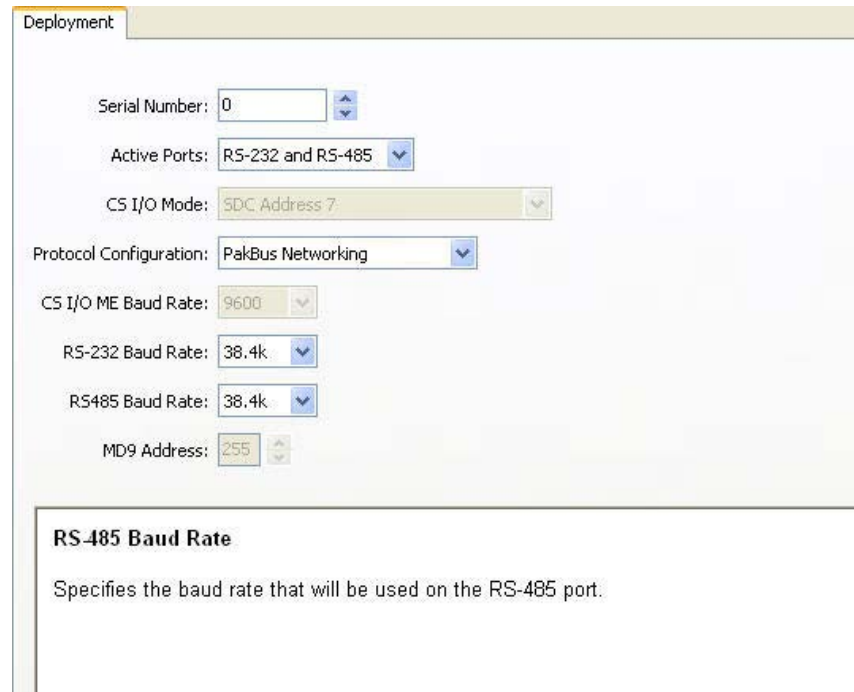

FIGURE G-2. Deployment tab in DevConfig with proper MD485 configuration.

AVW200 Configuration

The AVW200 is configured using DevConfig.

- a. Protocol – PakBus
- b. PakBus Address – set to a unique value for each AVW200 in the network
- c. RS-232 Baud Rate – 38.4k

Hardware Connections

Use the CABLE2TP cable to connect the MD485s to each other. Use a 18663 Null Modem Cable to connect the MD485 to the datalogger; one end of the null modem cable attaches to the RS-232 port on the MD485, and the other end attaches to the RS-232 port on the datalogger. Use another 18663 Null Modem Cable to connect each of AVW200s to an MD485; one end of the null modem cable attaches to the RS-232 port on the MD485, and the other end attaches to the RS-232 port on the AVW200.

Appendix H. MD485 Port Pin Descriptions

CS I/O Port

The CS I/O port is Campbell Scientific's input/output port. It is not a standard RS-232 pin-out. The following table provides pin-out information on the port when connected to a datalogger.

CS I/O CONNECTOR, 9-PIN D-SUB MALE

PIN	I/O	FUNCTION	DESCRIPTION
1	NC	5 V Supplied by Datalogger	Datalogger sources 5 VDC to power peripherals
2	GND	GND	GND
3	O	Ring	Raised by modem to put datalogger into telecommunications mode
4	O	RX	Serial data receive line
5	I	Modem Enable	Raised when datalogger determines that associated modem raised the ring line
6	I	Synchronous Device Enable	Used by datalogger to address synchronous devices; can be used as a printer enable
7	I	CLK/Handshake	Used by datalogger with SDE and TX lines to transfer data to synchronous devices
8	PWR	12 V Supplied by Datalogger	Datalogger sources 12 VDC to power peripherals
9	I	TX	Serial data transmit line

I = Signal Into the MD485, O = Signal Out of the MD485, NC = No Connection

RS-232 Port

The "RS-232" port is a partial implementation of RS-232C. It is configured as Data Communications Equipment (DCE) for direct cable connection to Data Terminal Equipment (DTE) such as a PC serial port.

RS-232 CONNECTOR, 9-PIN D-SUB FEMALE

PIN	I/O	FUNCTION
1	+5V	DCD
2	O	RXD
3	I	TXD
4	NC	DTR
5	GND	GND
6	+5V	DSR
7	NC	RTS
8	O	CTS
9	NC	RI

I = Signal Into the MD485, O = Signal Out of the MD485, NC = No Connection

RS-485 Port

RS-485 CONNECTOR, 3-PIN TERMINAL BLOCK

PIN	I/O	FUNCTION
1	GND	Signal Ground
2	I/O	485_IO- (A)
3	I/O	485_IO+ (B)

I = Signal Into the MD485, O = Signal Out of the MD485

Campbell Scientific Companies

Campbell Scientific, Inc. (CSI)

815 West 1800 North
Logan, Utah 84321
UNITED STATES

www.campbellsci.com • info@campbellsci.com

Campbell Scientific Africa Pty. Ltd. (CSAf)

PO Box 2450
Somerset West 7129
SOUTH AFRICA

www.csafrica.co.za • cleroux@csafrica.co.za

Campbell Scientific Australia Pty. Ltd. (CSA)

PO Box 444
Thuringowa Central
QLD 4812 AUSTRALIA

www.campbellsci.com.au • info@campbellsci.com.au

Campbell Scientific do Brazil Ltda. (CSB)

Rua Luisa Crapsi Orsi, 15 Butantã
CEP: 005543-000 São Paulo SP BRAZIL

www.campbellsci.com.br • suporte@campbellsci.com.br

Campbell Scientific Canada Corp. (CSC)

11564 - 149th Street NW
Edmonton, Alberta T5M 1W7
CANADA

www.campbellsci.ca • dataloggers@campbellsci.ca

Campbell Scientific Centro Caribe S.A. (CSCC)

300 N Cementerio, Edificio Breller
Santo Domingo, Heredia 40305
COSTA RICA

www.campbellsci.cc • info@campbellsci.cc

Campbell Scientific Ltd. (CSL)

Campbell Park
80 Hathern Road
Shepshed, Loughborough LE12 9GX
UNITED KINGDOM

www.campbellsci.co.uk • sales@campbellsci.co.uk

Campbell Scientific Ltd. (France)

Miniparc du Verger - Bat. H
1, rue de Terre Neuve - Les Ulis
91967 COURTABOEUF CEDEX
FRANCE

www.campbellsci.fr • info@campbellsci.fr

Campbell Scientific Spain, S. L.

Avda. Pompeu Fabra 7-9, local 1
08024 Barcelona
SPAIN

www.campbellsci.es • info@campbellsci.es

Please visit www.campbellsci.com to obtain contact information for your local US or International representative.