



VWIRE 305

8-Channel Dynamic Vibrating-Wire Analyzer



Table of contents

1. Introduction	1
2. Precautions	1
3. Initial inspection	1
4. Quickstart	2
4.1 Equipment	2
4.2 Procedure	3
5. Programming quickstart using DVW Toolbox	6
6. Overview	6
6.1 Input channels	7
6.2 Dynamic sample rates	7
6.3 Static measurement	7
6.4 Embedded thermistor or RTD	8
6.5 Rainflow histograms	8
6.6 Diagnostics	8
6.7 Data use	8
7. Specifications	9
7.1 Vibrating wire – specifications	9
7.2 Temperature – specifications	9
7.3 Module	10
7.3.1 Communications	10
7.3.2 System	10
7.3.3 Power requirements	10
7.3.4 Compliance	10
7.3.5 Physical attributes	10
8. Installation	11
8.1 Install driver for computer connection	11
8.2 Operating systems	11
8.3 Configuring VWIRE 305	12
8.3.1 Configuring using DVW Toolbox and LoggerNet	12
8.3.2 Configuring with the CPIAddModule() instruction	12

8.3.3 Configuring with Device Configuration Utility	12
8.3.4 Configuring with CPIStatus table	13
8.4 Data logger connection	14
8.5 Connecting multiple GRANITE Measurement Modules	14
8.5.1 Daisy-chain topology	14
8.5.2 Star topology	15
8.6 Power connection	16
8.6.1 Power-up sequence	16
8.7 Earth ground connection	17
8.8 Mounting in an enclosure	17
8.9 Field installation	18
8.9.1 Field installation equipment	18
8.9.2 Field installation procedure	19
9. Operation	21
9.1 VWIRE 305 sample rate	22
9.2 VWIRE 305 settings	23
9.3 VWIRE 305 outputs	28
9.4 Connections	31
9.4.1 Sensor connections	31
9.4.2 CPI network bit rate	32
9.5 Analyzers and channel numbers	33
9.6 Data logger program	33
9.6.1 Program code	34
9.6.1.1 Pipeline mode	34
9.6.1.2 VWIRE 305 programming	34
CDM_VW300Config()	34
CPIAddModule()	34
CDM_VW300Dynamic()	34
CDM_VW300Static()	34
CDM_VW300RainFlow()	35
RainFlowSample()	35
CPISpeed()	35
9.7 Data quality	35
9.7.1 Amplitude warning flags	35
9.7.2 Diagnostic codes	36
9.7.3 DVW Toolbox errors	37
9.7.4 Excitation strength	38

9.7.5 Frequency filters	38
9.7.5.1 Harmonics	39
9.7.5.2 Estimated frequency range	39
9.7.5.3 Actual frequency range	39
Matching estimated and actual frequency ranges	40
9.7.6 Frequency warning flags	41
9.7.7 Sample rate and noise performance	41
9.7.8 Standard deviation	41
9.8 Sensors	42
9.8.1 Sensor basic design features	42
9.8.2 Basic measurement of the sensor	42
9.8.3 Vibrating wire length and tension	42
9.8.4 Sensor output frequency range and maximum sample rate	43
9.8.5 Temperature sensor	43
9.9 Status of input channels and sensors	45
10. Troubleshooting	45
10.1 CPIStatus table	46
10.2 COMM status LED	47
10.3 CPI port LEDs	47
10.4 Replacing a GRANITE Measurement Module	47
11. References and attributions	48
Appendix A. VSPECT measurement theory	49
Appendix B. Vibrating wire digits conversion	50
Appendix C. Calculating vibrating wire measurement error	52
C.1 Error example: Geokon strain gage	52
C.2 Error example: DGSI embedment strain gage	53
C.3 Error example: DGSI spot-welded strain gage	53
C.4 Error example: Geokon 4420 crack meter	54
C.5 Error example: DGSI piezometer 52611099	54
Appendix D. Measuring thermistors and PRTs	55
D.1 Converting PRT resistance to temperature	55
D.2 Converting thermistor resistance to temperature	55
D.2.1 Thermistor measurement accuracy and resolution	56

Appendix E. Example programs	58
E.1 Configuring GRANITE Measurement Module with CPIAddModule()	58

1. Introduction

Designed around Campbell Scientific's VSPECT™ measurement technology, the VWIRE 305 Dynamic Vibrating Wire VSPECT Analyzers measure vibrating wire sensors at rates up to 333.3 Hz with high accuracy. You can use an analyzer without a data logger in a bench test, or one or more analyzers with a Campbell Scientific data logger in a field installation.

This manual discusses the use of the VWIRE 305 with the following products, which are sold separately:

- Wall Charger 12 VDC 800 mA Output, 100-240 VAC
- CPI Network Kit
- GRANITE data logger
- *LoggerNet* data logger support software

2. Precautions

- READ AND UNDERSTAND the [Safety](#) section at the back of this manual.
- WARNING:
 - Protect from over-voltage
 - Protect from water
 - Protect from ESD (electrostatic discharge)

3. Initial inspection

- Inspect the packaging and contents for damage immediately. File damage claims with the shipping company.
- Check packaging materials for all products. Check model numbers, part numbers, product descriptions, and cable lengths against shipping documents. Model or part numbers are found on each product. Cable numbers are normally found at the end of the cable that connects to the measurement device. Check that expected cable lengths were received. Contact Campbell Scientific immediately if you find any discrepancies.

- Check the operating system version in the VWIRE 305, and the data logger. Update as needed. See [Operating systems](#) (p. 11).

4. Quickstart

This procedure will get the VWIRE 305 set up to make measurements before connecting it to a GRANITE data logger. This procedure, makes real-time measurements of vibrating wire sensors. It does not store data (storing data requires an attached data logger).

4.1 Equipment

- Vibrating wire sensor
- VWIRE 305 analyzer
- Power supply (Wall Charger 12VDC 800mA Output, 100-240VAC 50 60Hz, 6ft Cable is used in this procedure)
- USB cable
- Computer
- *DVW Toolbox* software

The following figure shows a general schematic of connections:

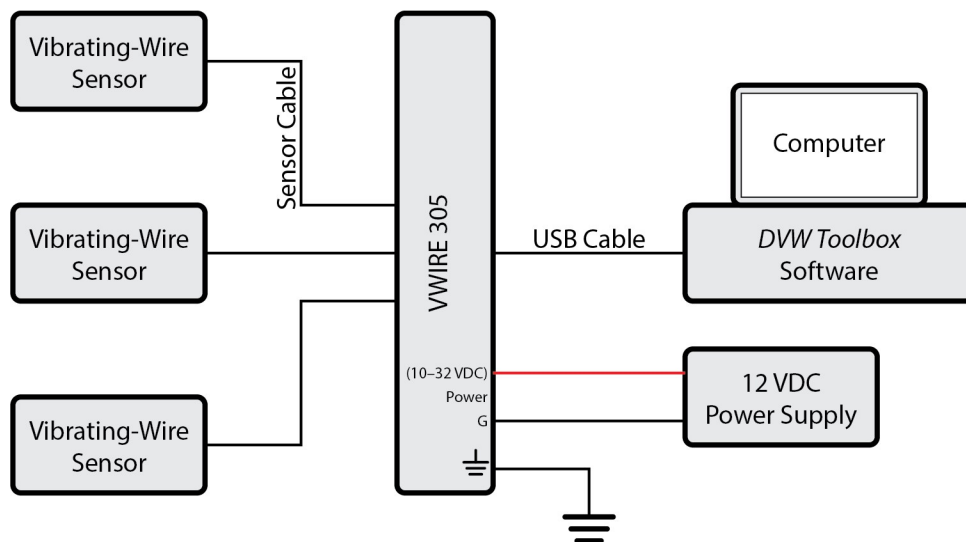

FIGURE 4-1. General schematic

4.2 Procedure

1. Install *DVW Toolbox* software on the computer. The *DVW Toolbox* installation also installs USB drivers for the VWIRE 305.
2. Connect the sensors to the VWIRE 305 (FIGURE 4-2 (p. 3) and FIGURE 4-3 (p. 3)). For further guidance on connecting sensors, see [Sensor connections](#) (p. 31).

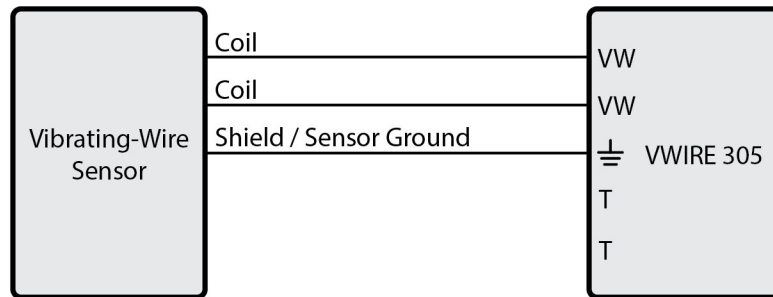

FIGURE 4-2. Three-wire sensor connection schematic (no embedded thermistor)

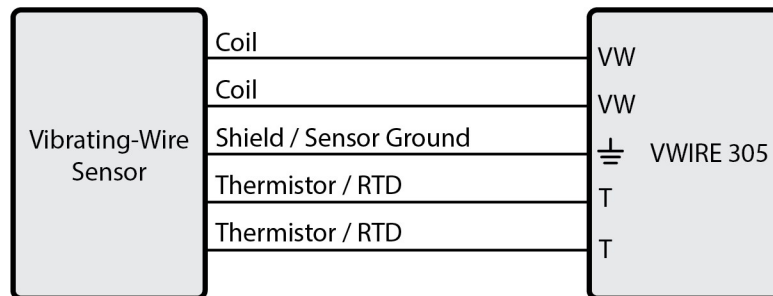

FIGURE 4-3. Five-wire sensor connection schematic

3. Connect the power supply to the VWIRE 305 power connector as shown.



FIGURE 4-4. Opening the power connector terminals

- Plug in the power supply. The VWIRE 305 **COMM Status** light flashes yellow. **Channel Status** lights may flash or remain dark.
- Connect the USB cable between a standard computer USB port and the VWIRE 305**USB** port.
- Open *DVW Toolbox*. A window similar to the following figure appears:

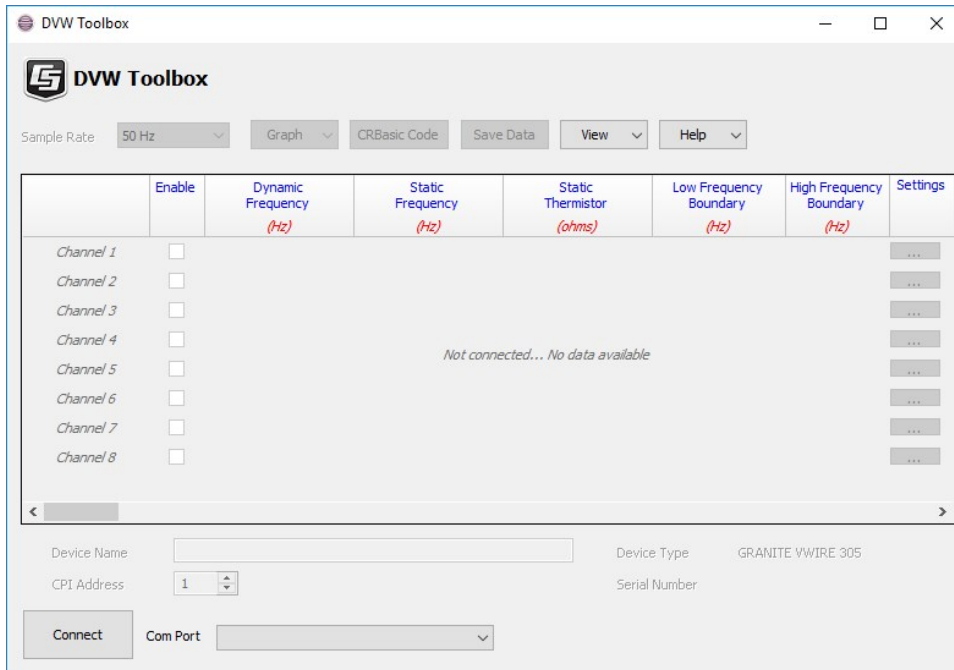

- In the **Com Port** list, select **CDM-VW300 (COMn)**.



The **Com Port** box displays **CDM-VW300 (COMn)**. Your **COMn** number may differ from that shown.

- Connect**

DVW Toolbox and the VWIRE 305 connect and the button at lower left will show **Disconnect**. **Device Type**, **Serial Number**, **Device Name**, and **CPI address** at lower center are active. Depending on the state in which the VWIRE 305 was last used, channels may or may not be enabled.

- Check the **Enable** box for channels to which sensors are connected. If the correct channels are selected, a green **Channel Status** flash indicates the sensor attached to that channel is working. Lights of disabled channels are dark. For other flash combinations, see [Status of input channels and sensors](#) (p. 45).

The main *DVW Toolbox* window will look similar to the following figure:

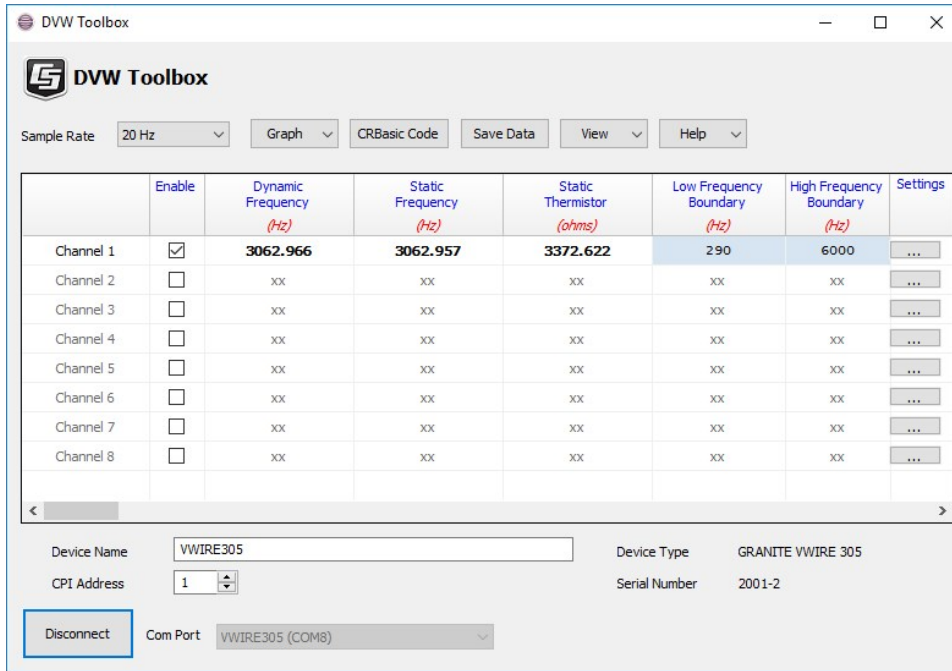

- If a sensor does not have a temperature sensing element, the value in the **Static Thermistor** column will be negative (**Channel 1**).
 - Reasonable values in the **Dynamic Frequency** and **Static Frequency** columns indicate the sensor outputs a vibrating wire signal. Check the values against the manufacturer provided documentation to see if sensor output is within the correct frequency output range.
 - The absence of information icons  indicates the VWIRE 305 detects no measurement faults. If you see an information icon, see [DVW Toolbox errors](#) (p. 37).
- For more information on adjusting **Sample Rate**, enabled channels, and **Frequency Boundaries** see [VWIRE 305 settings](#) (p. 23), and [VWIRE 305 outputs](#) (p. 28).

5. Programming quickstart using *DVW Toolbox*

Campbell Scientific *DVW Toolbox* is an easy way to generate a simple CRBasic program for your Campbell Scientific data acquisition system.

1. Configure the VWIRE 305 for measurements, see [Quickstart](#) (p. 2).
2. Select **CRBasic Code** then **Save...** and select the data logger you will be connecting the VWIRE 305 to.

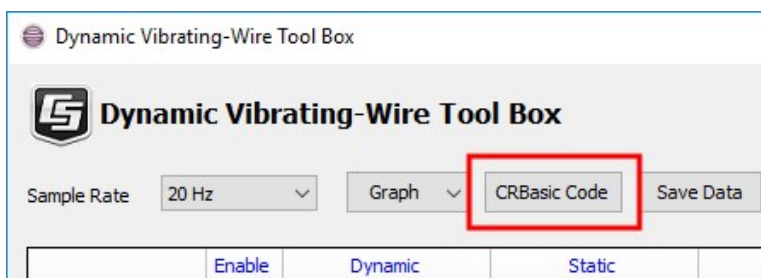

3. By default, the CRBasic program will be saved in C:\Campbellsci\DVWTool.

6. Overview

Vibrating wire sensors measure strain, load, tilt, inclination, temperature, pressure, extension, and crack movement. Measurements are stable and accurate, and sensors often survive a long time in harsh conditions. However, the conventional technology has two problems: sensors cannot be measured rapidly and, over a long time, sensor signal strength may be diminished.

The dynamic VSPECT measurement technology used in the VWIRE 305 overcomes these problems and yields measurements with superior precision and noise immunity.

[Quickstart](#) (p. 2) includes simplified procedures that give a good orientation of the equipment and software. There are nuances to the VWIRE 305 that can nullify the validity of measurements, so you should review this entire manual before collecting actionable data.

6.1 Input channels

The VWIRE 305 is an eight-channel module (FIGURE 6-1 (p. 7)). Each removable terminal strip measures two channels, and each channel measures one vibrating wire sensor and one embedded thermistor or RTD. All channels are measured simultaneously. Multiple modules can be connected to the data logger using the CPI bus. Use the CPI calculator at www.campbellsci.com/downloads/cpi-calculator to estimate the usage and capacity of a CPI network. Select a CDM-VW305 when using a VWIRE 305. To avoid skipped scans and frame errors with a VWIRE 305 network, the CPI bus load should not exceed 75%.



FIGURE 6-1. VWIRE 305

6.2 Dynamic sample rates

The VWIRE 305 makes dynamic measurements at 50, 20, 10, 5, or 3 mS (20, 50, 100, 200, or 333 Hz) depending on the resonant frequency. See Table 9-1 (p. 23).

6.3 Static measurement

As part of the dynamic measurement, the VWIRE 305 makes a static measurement at 1 Hz. The VWIRE 305 uses this measurement to get fine resolution in the dynamic-frequency measurements. The static measurement also helps detect when a noise frequency that is near the resonant frequency is affecting the dynamic measurement.

WARNING:

The program scan interval must be 50, 20, 10, 5, or 3 mS (20, 50, 100, 200, or 333 Hz) and `CDM_VW300Static()` must be called conditionally (using `TimeIntoInterval()`) at a 1 second interval (1 Hz). `TimeIntoInterval()` other than 1 second for static data may lead to CPI bus or data logger errors.

Additionally, `CDM_VW300Dynamic()` must be included in the main program scan.

6.4 Embedded thermistor or RTD

Vibrating wire sensors often have an embedded thermistor or RTD that measures the temperature of the sensor for compensation of thermal effects on the vibrating wire measurement. The VWIRE 305 measures this sensor at 1 Hz.

6.5 Rainflow histograms

Fatigue monitoring of large structures often uses rainflow histograms. The VWIRE 305 calculates histograms using the rainflow algorithm developed by Matsuishi and Endo (1968).

6.6 Diagnostics

The following diagnostic data are output with each dynamic measurement. You can use these data to evaluate measurement quality:

- Excitation level
- Low-frequency and high-frequency warnings
- Low-amplitude and high-amplitude warnings
- Standard deviation

6.7 Data use

Campbell Scientific does not make recommendations about how to interpret or use vibrating wire data, nor does it endorse the use of any specific manufacturer's sensors. Examples given in this manual are for educational purposes only. Consult competent and authoritative sources for guidance in selecting sensors and interpreting vibrating wire data.

7. Specifications

All Standard Duty (SD) VWIRE 305 units meet electrical specifications in a temperature range of -40 to 70 °C, non-condensing environment. Extended Duty (XD) units are tested over an extended temperature range of -55 to 85 °C.

7.1 Vibrating wire – specifications

VSPECT Technology Patents: U.S. Patent No. 7,779,690
U.S. Patent No. 8,671,758

Dynamic vibrating wire measurement rate: 20, 50, 100, 200, or 333.3 Hz. Depends on resonant frequency of the gages. See [Table 9-1](#) (p. 23).

Accuracy: ±(0.005 % of reading + effective measurement resolution)

Input resistance: 5 kΩ

Excitation voltage

Range: 0 to ±3 V (6 V peak-to-peak)

Resolution: 26 mV

Sensor resonant frequency output range: See column three of [Table 9-1](#) (p. 23).

Effective resolution (precision): 0.005 to 0.45 Hz RMS, depending on scan rate. See column five of [Table 9-1](#) (p. 23).

Sustained input voltage on measurement terminal without damage: -0.5 to 7.1 V

7.2 Temperature – specifications

Temperature measurement: 24-bit resistance measurement of thermistor or RTD embedded in the vibrating wire sensor.

Rate: 1 Hz

Accuracy: 0.15 % of reading. Does not include cable resistance error, or thermistor or RTD error.

Resolution:	0.002 Ω RMS @ 5 k Ω
Bridge resistor:	4.99 k Ω 0.1 %
Excitation voltage:	1.5 V

7.3 Module

7.3.1 Communications

CPI:	RJ45 interface to Campbell Scientific data loggers, sensors, and GRANITE Measurement Modules.
USB:	USB micro-B device only, 2.0 full-speed 12 Mbps, for computer connection.

7.3.2 System

Processor:	Renesas RX63N (32-bit with hardware FPU, running at 96 MHz)
Memory:	2 MB SRAM

7.3.3 Power requirements

Voltage:	10 to 32 VDC
Typical Current Drain:	190 mA @ 12 VDC 110 mA @24 VDC

7.3.4 Compliance

View EU Declarations of Conformity at www.campbellsci.com/vwire305 .

7.3.5 Physical attributes

Dimensions:	20.3 x 12.7 x 5.1 cm (8.0 x 5.0 x 2.0 in); additional clearance required for cables and wires
Weight:	<1 kg (2.0 lb)
Operating Temperature	
Standard Duty (SD):	-40 to 70 °C
Extended Duty (XD):	-55 to 85 °C

8. Installation

Preconfigure and test stations in an indoor location before doing the field installation.

After installing a field station, wait long enough to confirm that good measurements are being made, that data is collected by the data logger, and that data from the data logger can be copied to a computer.

8.1 Install driver for computer connection	11
8.2 Operating systems	11
8.3 Configuring VWIRE 305	12
8.4 Data logger connection	14
8.5 Connecting multiple GRANITE Measurement Modules	14
8.6 Power connection	16
8.7 Earth ground connection	17
8.8 Mounting in an enclosure	17
8.9 Field installation	18

8.1 Install driver for computer connection

Install the device driver before plugging the VWIRE 305 into your computer for the first time. You will need the device driver properly installed before you can connect to the VWIRE 305 via USB.

To install the device driver using the *Device Configuration Utility*, select **GRANITE > VWIRE 305**. Click the **Install the USB** driver link and follow the prompts.

TIP:

Driver installation is optional for computers running Windows 10 and later.

8.2 Operating systems

Campbell Scientific posts operating system (OS) updates at www.campbellsci.com/downloads[↗] when they become available. Before deploying instruments, check OS versions and update as needed to the most recent version. Use the *Device Configuration Utility* and follow the procedures on the **Send OS** tab.

NOTE:

For best performance, use the most recent OS for each device.

8.3 Configuring VWIRE 305

The VWIRE 305 arrives ready to be connected to a system. Device configuration is only required when multiple GRANITE Measurement Modules are connected to a single data logger. Each module must have a unique CPI address. Set a unique device name for further distinction between GRANITE Measurement Modules.

Configure the VWIRE 305 using one of four methods: through *DVW Toolbox*, the `CPIAddModule()` program instruction, *Device Configuration Utility* software, or the `CPIStatus` table.

8.3.1 Configuring using *DVW Toolbox* and *LoggerNet*

Modules are configured when connected to *DVW Toolbox*. *DVW Toolbox* sets the module CPI address to 1 and sets up the measurement channels.

For more information see [Quickstart](#) (p. 2)

8.3.2 Configuring with the `CPIAddModule()` instruction

To configure a VWIRE 305 within a program, use the `CPIAddModule()` instruction. A separate instruction is used for each device. The `CPIAddModule()` instruction overrides settings entered by other means, such as *Device Configuration Utility* or the `CPIStatus` table.

```
CPIAddModule(CDMType, CDMSerialNo, CDMDeviceName, CPIAddress)
```

The data logger creates an internal list of CPI modules from each `CPIAddModule()` instruction. Modules added to the CPI bus will be checked against this list and reconfigured accordingly.

NOTE:

The `CPIAddModule()` instruction overrides changes made through *Device Configuration Utility* or the `CPIStatus` table.

8.3.3 Configuring with *Device Configuration Utility*

Install the device driver before connecting the VWIRE 305 to a computer. This is optional for Windows 10, or later, operating systems.

1. Open *Device Configuration Utility*.
2. Under **Device Type**, select **GRANITE > VWIRE 305**.
3. Carefully review the Connect Instructions text provided on the right.
4. With the USB device driver installation complete, connect the supplied USB cable between the USB port on your computer and the **USB** port on the VWIRE 305.
5. Apply 9.6 to 32 VDC to the power terminals on the device.
6. Click the browse button next to **Communication Port**.
7. Select the port labeled **VWIRE 305**.
8. Click **OK**.
9. Click **Connect** then **OK** to avoid conflicts.
10. Set the **Device Name** (optional) and the **CPI Address**.
 - a. **Device Name** is a user-editable field to set a unique name to the VWIRE 305.
 - b. **CPI Address** specifies the address of the VWIRE 305. Each GRANITE Measurement Module connected to the same data logger must have a unique address. By default, the VWIRE 305 uses a CPI address of 1. Allowable addresses are 1 through 120.
11. Click **Apply** to save your changes.

8.3.4 Configuring with CPIStatus table

When a GRANITE Measurement Module is used in a program, the data logger adds a **CPIStatus** table to display current CPI information. View the **CPIStatus** table in the *LoggerNet* Connect screen, or *Device Configuration Utility Data Monitor* tab. Information about each module included in the data logger program or connected to the CPI bus appears in the **CPIStatus** table within the **ModuleInfo()** array. Information is shown in the following order:

GRANITE Measurement Module Type, Serial Number, Device Name, CPI Address, Activity, CDM OS Version

NOTE:

CDM OS version will be the last element in the **ModuleInfo()** array for VWIRE 305 modules with OS version 6 or newer.

Within the **ModuleInfo()** array index string, the Device Name and CPI Address fields can be edited. This provides a way to rename and readdress a VWIRE 305 through Campbell Scientific software without editing the CRBasic program or connecting directly to the **USB** port.

See [CPIStatus table](#) (p. 46) for additional information.

8.4 Data logger connection

VWIRE 305 devices communicate with a data logger through a **CPI** port. Each VWIRE 305 ships with a 6-inch RJ45 cable for this connection, though any CAT5e, or better, RJ45 cable can be used. To allow daisy-chaining, two **CPI** ports are available on the VWIRE 305. Either **CPI** port on the VWIRE 305 connects directly to the **CPI** port on a GRANITE 10, GRANITE 9, GRANITE 6, CR6, or CR1000X data logger.

8.5 Connecting multiple GRANITE Measurement Modules

The CPI bus, which handles the communications between the data logger and GRANITE Measurement Modules, can accept addresses **1 to 120**. Multiple GRANITE Measurement Modules may be connected to a single data logger using a daisy-chain or star topology. In both network configurations, as total cable length increases, the maximum possible bit rate decreases. Therefore, in networks with long cable lengths, it may be necessary to use the **CPI Speed()** instruction to decrease the CPI network bit rate from its default 250 kbps. Limitations on cable length and bit rate are discussed further in [CPI network bit rate](#) (p. 32) and listed in [Table 9-4](#) (p. 33).

Use the CPI calculator at www.campbellsci.com/downloads/cpi-calculator  to estimate the usage and capacity of a CPI network. Select a CDM-VW305 when using a VWIRE 305. To avoid skipped scans and frame errors with a VWIRE 305 network, the CPI bus load should not exceed 75%.

8.5.1 Daisy-chain topology

In a daisy-chain topology, GRANITE Measurement Modules are connected one after another, as shown in [FIGURE 8-1](#) (p. 15).

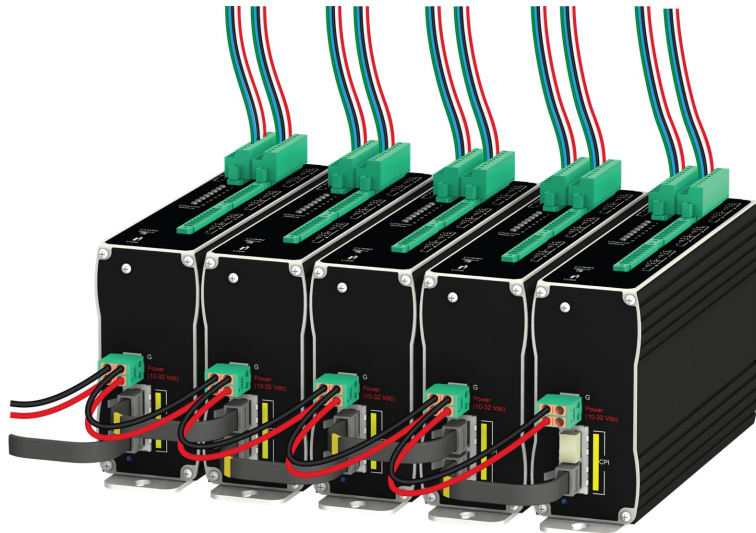

FIGURE 8-1. Multiple GRANITE Measurement Modules connected in a daisy-chain topology

For best performance, a CPI terminator (supplied in a CPI Network Kit) is installed in the open CPI port at the end of a daisy-chain network. For more information see: <https://s.campbellsci.com/documents/us/technical-papers/cpi-bus.pdf>

8.5.2 Star topology

A star topology uses a passive RJ45 hub, such as the HUB-CPI, to connect multiple GRANITE Measurement Modules. An illustration of this is shown in FIGURE 8-2 (p. 15).

NOTE:

Do not use a CPI terminator with this configuration.

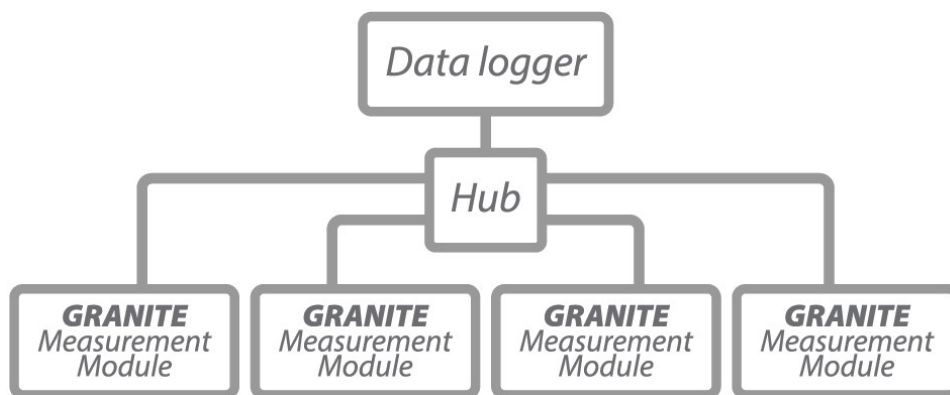

FIGURE 8-2. Multiple GRANITE Measurement Modules connected in a star topology

8.6 Power connection

Connect the power supply to the removable **Power** connector on the side of the VWIRE 305. Power supplies providing voltages from 9.6 to 32 VDC may be used.

- While the input power requirements of Campbell Scientific instruments vary, there is one constant – they all run on 12 VDC. To keep things simple, we only discuss the use of 12 VDC power supplies in this manual.
- Do not connect energized wires to an instrument. All connections discussed assume de-energized wires. Switch off power supplies before making connections.
- Double check the polarity of connections before switching on power supplies.

Open the power connector by inserting a screwdriver into the slots shown in [FIGURE 8-3](#) (p. 16). When the screwdriver is pushed in far enough, the orange terminals will open and remain open until the screwdriver is removed. The power connector includes two positive (+VDC) terminals and two negative (–VDC) terminals to allow for daisy-chaining power supplies. Terminals of the same type open and close together. Insert the positive wire from the power supply into a +VDC terminal, and insert the negative wire into a –VDC terminal.



FIGURE 8-3. Opening the power connector terminals

8.6.1 Power-up sequence

Best practice is to start all instruments in a station simultaneously from a single power supply. If this is not possible, first turn on VWIRE 305s, then the data logger. This procedure will reduce the time required to synchronize the CPI bus.

When the VWIRE 305 is turned on, the **COMM Status** light will flash yellow. Depending on the state the VWIRE 305 was left in when last turned on, one or more of the **Channel Status** lights may also flash.

See [COMM status LED](#) (p. 47) for more information.

8.7 Earth ground connection

Earth grounding provides protection from static discharge, transients, and power surges. A ground lug is provided on the VWIRE 305 for connection to earth ground, see . Minimum 14 AWG ground wire is recommended. The earth side of the connection should be to a grounding rod or other grounded device.

8.8 Mounting in an enclosure

Campbell Scientific data loggers and GRANITE Measurement Module brackets have mounting holes through which small screws are inserted into nylon anchors in an enclosure backplate.



FIGURE 8-4. Enclosure backplate mounting

If mounting to a DIN rail, use the GRANITE-series DIN-Rail Kit as shown in the following images.

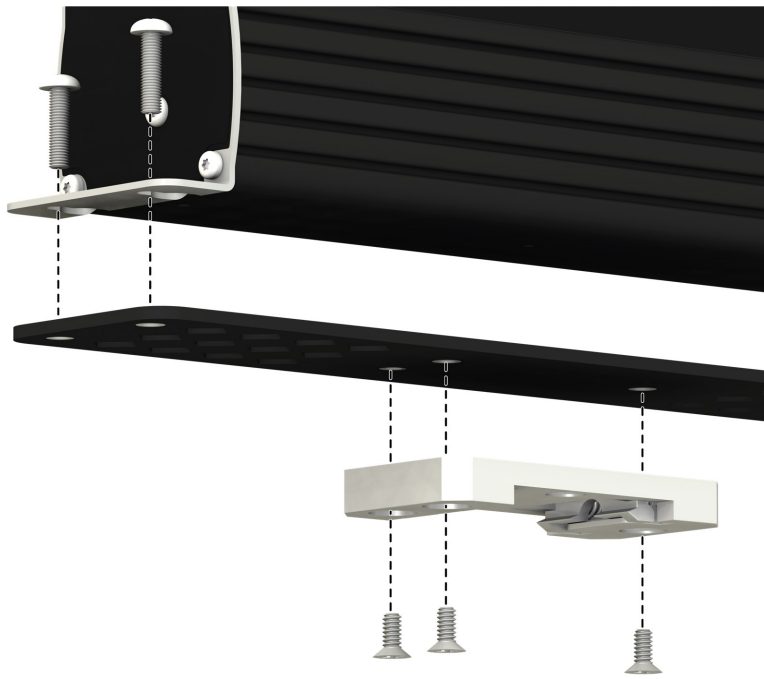

FIGURE 8-5. GRANITE DIN-Rail Mounting Kit

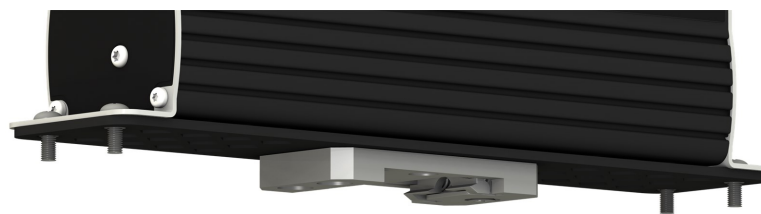

FIGURE 8-6. DIN rail mounting

8.9 Field installation

This section discusses installation of a simple VWIRE 305 field station. Unlike the quickstart, a field station includes a data logger to control and collect data from the VWIRE 305. Capacity of the power supply is CRITICAL. VWIRE 305 field stations require continuous AC power or large solar panels and batteries. See [Power connection](#) (p. 16). If switching back and forth between *DVW Toolbox* and data logger control, cycle the power after each switch to let the VWIRE 305 adapt to the new connection.

8.9.1 Field installation equipment

- Vibrating wire sensor
- VWIRE 305 analyzer

- GRANITE data logger
- Power supply
- Computer
- *DVW Toolbox* software
- *LoggerNet* software
- RJ45 cabling
- USB link with GRANITE data logger for initial setup. Other communications link may be needed for long term monitoring.

FIGURE 8-7 (p. 19) provides a general schematic of a simple field station.

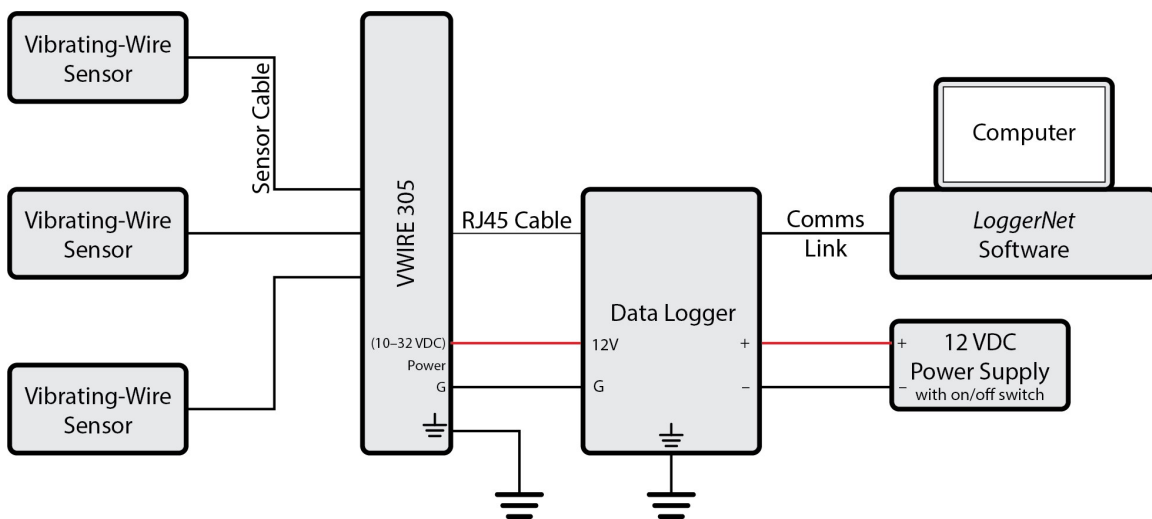

FIGURE 8-7. General schematic of simple field station

8.9.2 Field installation procedure

1. Do [Quickstart](#) (p. 2) and [Programming quickstart using DVW Toolbox](#) (p. 6).
2. Click **Disconnect** in *DVW Toolbox*. Switch off the power supply.
3. Connect the GRANITE data logger **CPI** port to the VWIRE 305 **CPI** port using an RJ45 terminated CAT5e, or better, cable.
4. Place the CPI terminator (supplied in GRANITE Network Kit) in the remaining open **CPI** port as shown below.

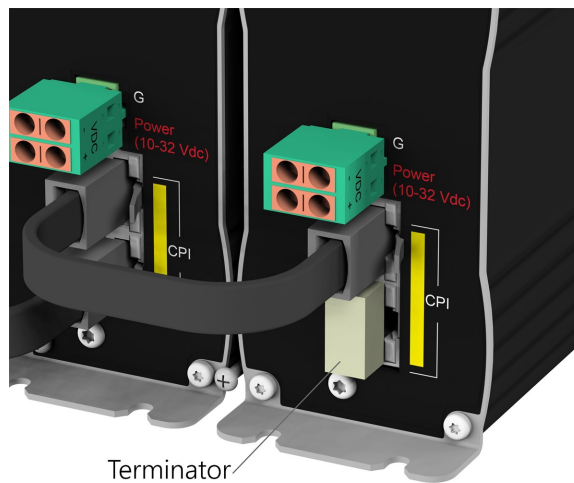

FIGURE 8-8. CPI terminator placement

5. Interconnect ground lugs to an Earth ground. Use 14 AWG wire or larger. See Section 7.4.4, Ground Connections (p. 23).
6. Connect the GRANITE to the power supply.
7. Switch on the power supply. During power up, lots of lights flash. After things settle down (5 to 10 seconds), **Channel Status** lights should flash green (because you already performed the bench test procedure). The **COMM Status** light should flash red.
8. Send the CRBasic program created with *DVW Toolbox* using the program **Send** command in **LoggerNet > Connect**. When the program has compile, CPI network becomes active as indicated by a flashing green **COMMS Status** light and flashing green and yellow lights on the GRANITE CPI port.
9. In **LoggerNet > Connect**, monitor the system by viewing the variables: **Freq**, **Diag**, **StaticFreq**, **Therm**, and **DynStdDev**.

For example, consider a station that includes a VWIRE 305 analyzer with a sensor connected to input channel 1. In the **Numeric Monitor**, the data logger **Public** table will look similar to the following figure:

RecNum	75001	StaticFreq(1)	3062.588	DynStdDev(3)	0
TimeStamp	'2019 12:58:28	StaticFreq(2)	0	DynStdDev(4)	0
Freq(1)	3062.594	StaticFreq(3)	0	DynStdDev(5)	0
Freq(2)	0	StaticFreq(4)	0	DynStdDev(6)	0
Freq(3)	0	StaticFreq(5)	0	DynStdDev(7)	0
Freq(4)	0	StaticFreq(6)	0	DynStdDev(8)	0
Freq(5)	0	StaticFreq(7)	0		
Freq(6)	0	StaticFreq(8)	0		
Freq(7)	0	Therm(1)	3214.582		
Freq(8)	0	Therm(2)	0		
Diag(1)	255	Therm(3)	0		
Diag(2)	0	Therm(4)	0		
Diag(3)	0	Therm(5)	0		
Diag(4)	0	Therm(6)	0		
Diag(5)	0	Therm(7)	0		
Diag(6)	0	Therm(8)	0		
Diag(7)	0	DynStdDev(1)	0.01027702		
Diag(8)	0	DynStdDev(2)	0		

Only variables **Freq(1)**, **Diag(1)**, **StaticFreq(1)**, **Therm(1)**, **DynStdDev(1)** have data, indicating channel 1 is active.

10. Collect and verify data in the other data tables before leaving the field.

9. Operation

9.1 VWIRE 305 sample rate	22
9.2 VWIRE 305 settings	23
9.3 VWIRE 305 outputs	28
9.4 Connections	31
9.5 Analyzers and channel numbers	33
9.6 Data logger program	33
9.7 Data quality	35
9.8 Sensors	42
9.9 Status of input channels and sensors	45

9.1 VWIRE 305 sample rate

The sample rate, the rate at which the VWIRE 305 measures the vibrating wire signal, is a key setting from which other VWIRE 305 settings and outputs are derived. The allowed sample rate is a function of the natural-resonant frequency of the sensor. For example, if a strain gage is designed to operate with a frequency between 500 – 1200 Hz, do not sample it faster than 50 Hz.

The following table lists the five available sample rates and their specifications. This table is referenced throughout this manual.

Table 9-1: VWIRE 305 sample rates and specifications

Sample rate ¹ (Hz)	Scan interval (mSec)	Sensor resonance ² (Hz)	Sensor resonance range boundary resolution (Hz)	Noise level ³ (Hz RMS)	Maximum supported channels ⁴	Maximum VWIRE 305s
1				0.005		
20	50	290 – 6000	47.68	0.008	64	8
50	20	290 – 6000	95.37	0.015	32	4
100	10	580 – 6000	190.73	0.035	24	3
200	5	1150 – 6000	381.47	0.11	24	3
333.3	3	2300 – 6000	762.94	0.45	16	2

¹ Rates include the time needed to write data to a memory card. They do not include time needed to measure sensors outside the VWIRE 305 network. The fastest that a vibrating wire gage can be measured is approximately 20 percent of the resonant frequency.

² Find the output range of a sensor in the documentation sent by the manufacturer.

³ Usual values for a 2500 Hz resonant sensor

⁴ Specifications are subject to installation factors such as CPI bus speed, CPI cable length, and unrelated demands on the data logger.

9.2 VWIRE 305 settings

Settings configure the VWIRE 305. Use *DVW Toolbox* software to edit and apply settings.

NOTE:

The GRANITE data logger re-configures the VWIRE 305 when it is connected regardless of what was done in *DVW Toolbox*. To get *DVW Toolbox* settings to persist do the configuration in *DVW Toolbox*, then have *DVW Toolbox* write the data logger program (**CRBasic Code** button), then load that program into the GRANITE data logger.

The following table summarizes VWIRE 305 settings and how to access them in *DVW Toolbox* and *CRBasic Editor*.

Table 9-2: VWIRE 305 settings

Setting (alphabetically)	Definition	DVW Toolbox location, options/range	CRBasic Editor instruction, parameter (arguments)
Channel Enable	Activates a VWIRE 305 input channel	<ul style="list-style-type: none"> Main window, left Enable column check box 	<ul style="list-style-type: none"> <code>CDM_VW300Config()</code> <code>ChanEnable</code> (0 or 1)
CPI Address	Address of VWIRE 305 on the CPI network	<ul style="list-style-type: none"> Main window, lower left 1 to 120 	<ul style="list-style-type: none"> <code>CDM_VW300Config()</code> <code>CPIAddress</code> (1 to 120)
CPI Speed	Rate of CPI network communications. Default is usually OK.	<ul style="list-style-type: none"> Main window, lower center Auto-Detect, 50, 125, 250, 500, 1000 (kbps) 	<ul style="list-style-type: none"> <code>CPISpeed()</code> <code>BitRate</code> (50, 125, 250, 500, and 1000 kbps) Usually optional. Default is 250 if <code>CPISpeed()</code> not in program.
Device Name	Optional VWIRE 305 alphanumeric name.	<ul style="list-style-type: none"> Main window, lower left Optional 	<ul style="list-style-type: none"> Visible in the CPI_Status Table
Device Type	Identifies the VWIRE 305 to CRBasic.	<ul style="list-style-type: none"> Main window Auto detected 	<ul style="list-style-type: none"> <code>CDM_VW300Config()</code> <code>DeviceType</code> VWIRE305
DVW Toolbox Update Rate	<i>DVW Toolbox</i> data display rate. Default is usually OK.	<ul style="list-style-type: none"> Click View > Advanced Main window, lower right 	n/a
High-Frequency Boundary	Upper boundary of the operator-determined range of valid resonant frequencies. See Diagnostic codes (p. 36).	<ul style="list-style-type: none"> Click Settings Range: 290 to 6000 Hz View/set in main window 	<ul style="list-style-type: none"> <code>CDM_VW300Config()</code> <code>HighFreq</code> (290 to 6000 Hz)

Table 9-2: VWIRE 305 settings

Setting (alphabetically)	Definition	DVW Toolbox location, options/range	CRBasic Editor instruction, parameter (arguments)
Low-Frequency Boundary	Lower boundary of the operator-determined range of valid resonant frequencies. See Diagnostic codes (p. 36).	<ul style="list-style-type: none"> Click Settings Range: 290 to 6000 Hz View/set in main window 	<ul style="list-style-type: none"> <code>CDM_VW300Config()</code> <code>LowFreq (290 to 6000 Hz)</code>
Multiplier	Slope or gain applied to the raw measurement. See Vibrating wire digits conversion (p. 50), and Calculating vibrating wire measurement error (p. 52).	<ul style="list-style-type: none"> Click Settings Click View > Frequency Conversion to view/set in main window 	<ul style="list-style-type: none"> <code>CDM_VW300Config()</code> <code>Mult</code>
Offset	Offset or y-intercept applied to the raw measurement. See Vibrating wire digits conversion (p. 50), and Calculating vibrating wire measurement error (p. 52).	<ul style="list-style-type: none"> Click Settings Click View > Frequency Conversion to view/set in main window 	<ul style="list-style-type: none"> <code>CDM_VW300Config()</code> <code>Offset</code>

Table 9-2: VWIRE 305 settings

Setting (alphabetically)	Definition	DVW Toolbox location, options/range	CRBasic Editor instruction, parameter (arguments)
Output Format	Sets the units for the output data.	<ul style="list-style-type: none"> • Click Settings • Options: Hz, Hz2, Digits, Scaled Hz, or Scaled Hz2 • Click View > Frequency Conversion to view/set in main window 	<ul style="list-style-type: none"> • CDM_VW300Config() • ChanOptions (Hz, Hz2)
Rainflow Form	Sets form of output for a rainflow histogram.	<ul style="list-style-type: none"> • Click Graph > Rainflow Histogram Channel n • Click lists then F1 for guidance. 	<ul style="list-style-type: none"> • CDM_VW300Config() • RF_Form
Rainflow High Limit	High limit in a rainflow histogram.	<ul style="list-style-type: none"> • Click Graph > Rainflow Histogram Channel n • Click field then F1 for guidance. 	<ul style="list-style-type: none"> • CDM_VW300Config() • RF_HighLim
Rainflow Low Limit	Low limit in a rainflow histogram.	<ul style="list-style-type: none"> • Click Graph > Rainflow Histogram Channel n • Click field then F1 for guidance. 	<ul style="list-style-type: none"> • CDM_VW300Config() • RF_LowLim

Table 9-2: VWIRE 305 settings

Setting (alphabetically)	Definition	<i>DVW Toolbox</i> location, options/range	<i>CRBasic Editor</i> instruction, parameter (arguments)
Rainflow Minimum Change	Minimum change in a rainflow histogram.	<ul style="list-style-type: none"> Click Graph > Rainflow Histogram Channel n Click field then F1 for guidance. 	<ul style="list-style-type: none"> CDM_VW300Config() RF_Hyst
Rainflow Number of Amp Bins	Number of amplitude bins in a rainflow histogram.	<ul style="list-style-type: none"> Click Graph > Rainflow Histogram Channel n Click field then F1 for guidance. 	<ul style="list-style-type: none"> CDM_VW300Config() RF_MeanBins
Resonant Amplitude	Amplitude target. VWIRE 305 automatically adjusts the vibrating wire excitation to maintain the target. Default (2 mV or 0.002 V) is usually OK	<ul style="list-style-type: none"> Click Settings Range: 1 to 10 mV View > Advanced to view/set 	<ul style="list-style-type: none"> CDM_VW300Config() ResonAmp (0.001 to 0.010 V)
Sample Rate	Rate at which the VWIRE 305 samples vibrating wire resonant frequencies. Sample rate determines the range of frequencies that can be measured as listed in the third column of Table 9-1 (p. 23).	<ul style="list-style-type: none"> Main window upper left Options: 20, 50, 100, 200, 333.3 (Hz) 	<ul style="list-style-type: none"> Scan() Interval (50, 20, 10, 5, 3) Units (mSec)

Setting (alphabetically)	Definition	DVW Toolbox location, options/range	CRBasic Editor instruction, parameter (arguments)
Steinhart-Hart Thermistor Coefficient A, B, C	Thermistor coefficients. See Measuring thermistors and PRTs (p. 55)	<ul style="list-style-type: none"> Click Settings View > Temperature Conversion to view/set 	<ul style="list-style-type: none"> CDM_VW300Config() SteinA, SteinB, SteinC
System options	Determines if a numeric value or NAN is stored in data logger memory when a warning flag is raised, and whether or not diagnostic lights are active. See <i>CRBasic Editor</i> Help topic CDM_VW300Config() SysOptions and Table 9-6 (p. 45).	n/a	<ul style="list-style-type: none"> CDM_VW300Config() SysOptions (0, 1, 10, 11)

9.3 VWIRE 305 outputs

The following table summarizes VWIRE 305 outputs in *DVW Toolbox* and *CRBasic Editor*.

Table 9-3: VWIRE 305 outputs

Output	Definition	DVW Toolbox location, options	CRBasic Editor instruction, output variable parameter
Actual Low Frequency	Low-frequency boundary set by the VWIRE 305 based on the operator-entered VWIRE 305 settings (p. 23) and the results of measurements.	View > Advanced then main screen	n/a
Actual High Frequency	High-frequency boundary set by the VWIRE 305 based on the operator-entered VWIRE 305 settings (p. 23) and the results of measurements.	View > Advanced then main screen	n/a
Diagnostic Code	Diagnostic code includes: <ul style="list-style-type: none"> • Excitation strength • Low-amplitude flag • High-amplitude flag • Low-frequency flag • High-frequency flag 	Click information icon  in Channel column.	<ul style="list-style-type: none"> • CDM_VW300Dynamic() • DestDiag
Dynamic Output	Dynamic resonant output of the vibrating wire sensor.	Main screen	<ul style="list-style-type: none"> • CDM_VW300Dynamic() • DestFreq

Table 9-3: VWIRE 305 outputs

Output	Definition	DVW Toolbox location, options	CRBasic Editor instruction, output variable parameter
Excitation Strength	Voltage of the vibrating wire excitation expressed in bits $2^0 - 2^7$ of the diagnostic code	View > Advanced then main screen	n/a
OS Date	Date the operating system was released	Help > About	n/a
OS Version	Version of the VWIRE 305 operating system	Help > About	n/a
Serial Number	Serial number of the VWIRE 305	Main screen lower center	n/a
Std Dev of Dyn Freq	Standard deviation of the dynamic output computed on one-second data and output at 1 Hz.	View > Advanced then main screen	<ul style="list-style-type: none"> • <code>CDM_VW300Static()</code> • <code>DestStdDev</code>
Static Output	Static resonant output of the vibrating wire sensor.	Main screen	<ul style="list-style-type: none"> • <code>CDM_VW300Static()</code> • <code>DestFreq</code>
Static Thermistor	Temperature of the thermistor or resistance of the thermistor or RTD that is embedded in the vibrating wire sensor. See Steinhart-Hart Thermistor Coefficient A, B, and C setting VWIRE 305 settings (p. 23).	Main screen	<ul style="list-style-type: none"> • <code>CDM_VW300Static()</code> • <code>DestTherm</code>

9.4 Connections

9.4.1 Sensor connections31
9.4.2 CPI network bit rate32

9.4.1 Sensor connections

Vibrating wire sensors have either a three- or five-wire configuration. The five-wire configuration includes a thermistor or RTD embedded in the body of the sensor. Refer to the sensor documentation provided by the manufacturer to confirm the function of each wire.

As shown in [FIGURE 9-1](#) (p. 31), three-wire sensors have two wires that bridge the sensor coil to the two **VW** terminals on the input channel. The **VW** terminals have no polarity. The third wire is a cable shield that bridges the sensor ground to the \perp terminal.

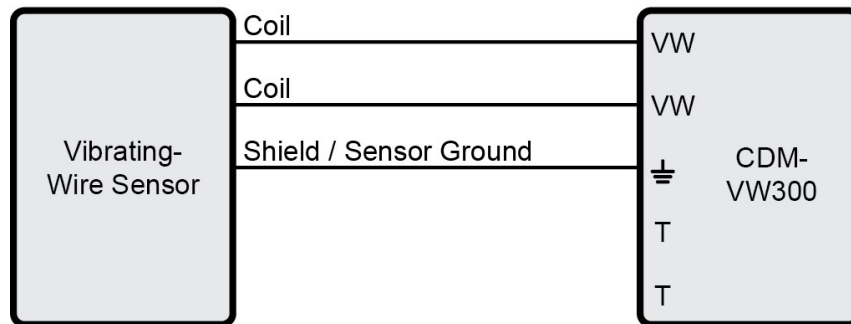

FIGURE 9-1. Three-wire sensor connection schematic (no embedded temperature sensor)

Temperature changes in the body of a vibrating wire sensor can cause measurement errors. The embedded thermistor or RTD in a five-wire sensor measures temperature change so that a compensation algorithm can be applied to the output data.

As shown in [FIGURE 9-2](#) (p. 32), five-wire sensors have two additional wires that bridge the embedded thermistor or RTD to the two **T** terminals on the input channel. **T** terminals have no polarity.

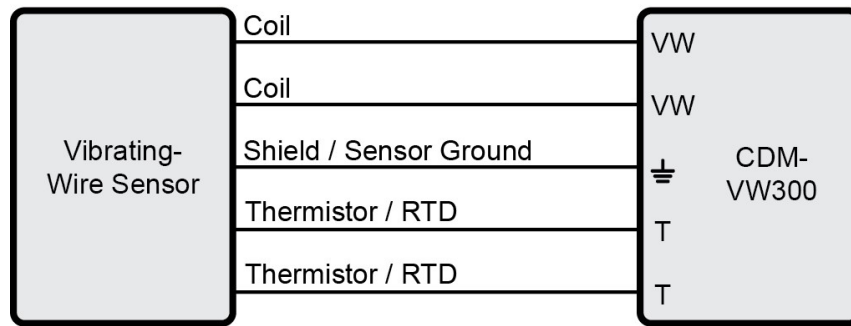

FIGURE 9-2. Five-wire sensor connection schematic

9.4.2 CPI network bit rate

A CPI network is capable of operating at 1000, 500, 250, 125, or 50 kbps, depending on your network configuration (see [Connecting multiple GRANITE Measurement Modules](#) (p. 14)). This is the rate that data are transferred from the GRANITE Measurement Module to the data logger. When multiple GRANITE Measurement Modules are making measurements faster than 1 Hz, it is important to ensure that the CPI network bit rate is higher than the rate that data is generated by the GRANITE Measurement Modules within the network.

To calculate how many kilobits per second (kbps) will be generated, use the following **equation** for each GRANITE Measurement Module in your network:

$$\text{Kilobits per second} = (\text{number of measurements}) \times (\text{measurement frequency}) \times (0.064 \text{ kilobits per measurement})$$

The network topology and cable length affect the maximum allowable CPI network bit rate. Refer to [Table 9-4](#) (p. 33) for the maximum cable length allowed for the topology and bit rate your network requires. The bit rate of the network defaults to 250 kbps and can be changed by using the [CPISpeed\(\)](#) instruction in the data logger program.

Table 9-4: Network topology, bit rate, and cable length

Bit Rate ¹ (kbps)	Maximum total cable length (ft)		
	Daisy-chain topology		Star topology
	Full termination	Half termination	No termination
1000	50	1	not viable
500	200	200	100
250	500	400	400
125	1200	1000	1000
50	2800	2400	2400

¹ Default Bit Rate is 250 kbps. Change with `CPISpeed()` instruction.

9.5 Analyzers and channel numbers

Use the CPI calculator at www.campbellsci.com/downloads/cpi-calculator to estimate the usage and capacity of a CPI network. Select a CDM-VW305 when using a VWIRE 305. To avoid skipped scans and frame errors with a VWIRE 305 network, the CPI bus load should not exceed 75%.

NOTE:

Each analyzer requires the same system bandwidth whether or not all channels are active.

The sample rate determines the maximum number of vibrating wire sensors that can be measured in a VWIRE 305 CPI network. See the seventh and eighth column in [Table 9-1](#) (p. 23).

NOTE:

These channel counts do not account for other devices on the CPI bus or other measurement or computation loads on the data logger.

9.6 Data logger program

The data logger controls and collects data from the VWIRE 305, and the CRBasic program controls the data logger. In most applications that use one analyzer, let *DVW Toolbox* generate the program. After setting up the VWIRE 305 and sensors, generate the program by clicking the **CRBasic Code** button in the main *DVW Toolbox* window. Save the program to a file, or copy and paste the displayed code into the *CRBasic Editor*.

9.6.1 Program code

If you use more than one analyzer with a single data logger, or need a non-standard program, you can write a new program or edit an existing program using *CRBasic Editor*. See <https://www.campbellsci.com/downloads/vwire-example> for a complete example program.

The following sections give short descriptions of VWIRE 305 related CRBasic instructions. The [CRBasic Editor Help](#) has full descriptions of these instructions.

9.6.1.1 Pipeline mode

When controlling the VWIRE 305, the data logger automatically runs the CRBasic program in pipeline mode to synchronize all measurement and control functions on the CPI network. You can read more about pipeline mode in the data logger manual.

9.6.1.2 VWIRE 305 programming

CDM_VW300Config()

CDM_VW300Config() sends configuration settings to the VWIRE 305. Place it before the **BeginProg** statement. It does not set the CPI address of the VWIRE 305. See [Configuring VWIRE 305](#) (p. 12) for more information on setting the CPI address.

```
CDM_VW300Config(DeviceType, CPIAddress, SysOption, ChanEnable, ResonAmp, LowFreq, HighFreq, ChanOptions, Mult, Offset, SteinA, SteinB, SteinC, RF_MeanBins, RF_AmpBins, RF_LowLim, RF_HighLim, RF_Hyst, RF_Form)
```

CPIAddModule()

See [Configuring with the CPIAddModule\(\) instruction](#) (p. 12).

CDM_VW300Dynamic()

This instruction captures the dynamic output. Place it inside the main scan of the program.

```
CDM_VW300Dynamic(CPIAddress, DestFreq, DestDiag)
```

CDM_VW300Static()

This instruction captures static frequency, standard deviation of dynamic frequency at 1 Hz, and temperature of the embedded thermistor or RTD. It is used in the main scan inside an **If TimeIntoInterval()** conditional statement. Set **TimeIntoInterval()** to capture static data at 1 Hz.

```
If TimeIntoInterval(0, 1, Sec) Then  
  CDM_VW300Static(CPIAddress, DestFreq, DestTherm, DestStdDev)  
  ...  
EndIf
```

CDM_VW300RainFlow()

Place this instruction in a slow sequence to capture data for a rainflow histogram. See [SlowSequence](#) instruction in *CRBasic Editor* software Help.

```
CDM_VW300RainFlow(CPIAddress, RF1, RF2, RF3, RF4, RF5, RF6, RF7, RF8)
```

RainFlowSample()

This instruction writes rainflow histogram data to a data table. The data table is usually set up to store data once per minute. See [DataTable](#) instruction in *CRBasic Editor* software Help.

```
RainFlowSample(Source, DataType)
```

CPISpeed()

This instruction controls the speed of the CPI bus. This instruction is not normally needed. Use it only when CPI bus communications need adjustment.

```
CPISpeed(BitRate)
```

9.7 Data quality

The VWIRE 305 and *DVW Toolbox* have the following features to help you evaluate the quality of vibrating wire data. For more discussion about some of these features, see [VSPECT measurement theory](#) (p. 49).

9.7.1 Amplitude warning flags	35
9.7.2 Diagnostic codes	36
9.7.3 DVW Toolbox errors	37
9.7.4 Excitation strength	38
9.7.5 Frequency filters	38
9.7.6 Frequency warning flags	41
9.7.7 Sample rate and noise performance	41
9.7.8 Standard deviation	41

9.7.1 Amplitude warning flags

An accurate measurement requires the resonant amplitude of the sensor to be greater than 50 % and less than 200 % of the **Resonant Amplitude** setting. If the resonant amplitude is less than 50 % of the resonant amplitude setting, a low-amplitude warning flag is triggered. Greater than 200

% triggers a high-amplitude warning flag. Most sensors respond well to the default amplitude setting. Weak sensors will require a stronger excitation pulse to achieve the amplitude setting target value. Raising the amplitude setting gives a larger signal-to-noise ratio but subjects the sensor to stronger excitation energy.

When the frequency of a sensor changes fast, the measured phenomenon is probably changing fast. When this happens, energy in the vibrating wire may drop briefly until the excitation mechanism can insert energy at the new frequency. A low-amplitude warning flag may occur briefly; this is usually OK.

If a warning flag is present for a long time, check the source of the error as follows:

- Check the sensor connection.
- Check that the sensor is outputting correct data.
- Fine tune the VWIRE 305 scan rate. See **Sample Rate** in [Table 9-2](#) (p. 24).
- Check that the frequency being output by the sensor is within one of the frequency output ranges supported by the VWIRE 305. See the first and third columns in [Table 9-1](#) (p. 23).

9.7.2 Diagnostic codes

The VWIRE 305 outputs binary diagnostic codes with each measurement at the VWIRE 305 sample rate. These codes include information about excitation strength, frequency warning flags, and amplitude warning flags.

When using a data logger with the VWIRE 305, write program code to interpret the diagnostic codes. An alternative is to save diagnostic codes with the measurement data and interpret the codes with post processing.

Each diagnostic code is a 32 bit unsigned integer encoded with the following diagnostic parameters.

- Excitation strength
- Low-amplitude warning flag
- High-amplitude warning flag
- Low-frequency warning flag
- High-frequency warning flag

When there are no warning flags, the diagnostic code is between 0 and 255 and indicates only excitation strength. When there are warning flags the diagnostic code is greater than 255 and is the sum of the excitation strength and the flag value. The following table summarizes diagnostic codes that indicate warning flags:

Table 9-5: Diagnostic code ranges

Diagnostic code range ¹	Excitation only	Low-amplitude warning flag present ²	High-amplitude warning flag present ²	Low-frequency warning flag present ²	High-frequency warning flag present ²
0 – 255	✓				
256 – 511		✓			
512 – 767			✓		
768 – 1023					
1024 – 1279				✓	
1280 – 1535		✓		✓	
1536 – 1791			✓	✓	
1792 – 2047					
2048 – 2303					✓
2304 – 2559		✓			✓
2560 – 2815			✓		✓

¹ Diagnostic codes outside these ranges may occur when hardware, firmware, or CRBasic programming errors occur.

² Amplitude warning flags and frequency warning flags have the following restrictions:

- A measurement can have a low-amplitude warning flag or high-amplitude warning flag, but not both.
- A measurement can have a low-frequency warning flag or a high-frequency warning flag, but not both.
- A measurement can have both an amplitude warning flag and a frequency warning flag.

9.7.3 DVW Toolbox errors

As shown in FIGURE 9-3 (p. 38), *DVW Toolbox* Error Indicators, *DVW Toolbox* indicates measurement errors in the following ways:

- Information icon  in the **Channel**. Click icon for more information.
- Red or flashing-red measurement values

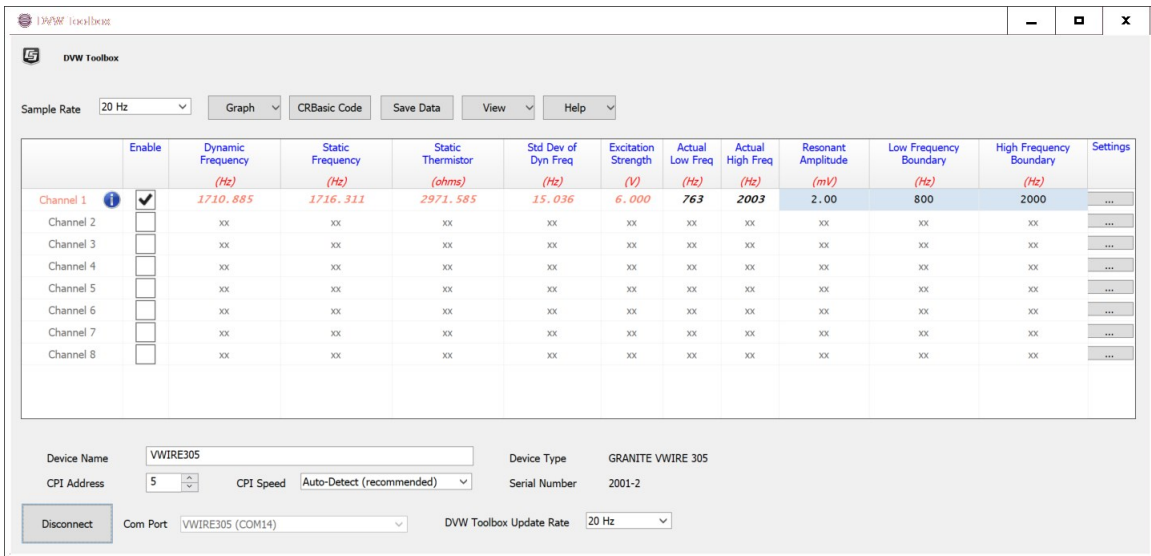

FIGURE 9-3. DVW Toolbox error indicators

9.7.4 Excitation strength

Excitation strength is output with each dynamic measurement as part of the diagnostic code. See [Diagnostic codes](#) (p. 36). If it changes significantly, spend time to figure out what is causing the change. Significance of change depends on the application, but a sudden or large permanent change from a baseline (be sure to determine and record a baseline when first installing a station) indicates there is likely a problem with the sensor.

An increase in excitation strength usually means the sensor is less responsive, so it must be driven harder to get the same response. Some sensors become less responsive with age.

A change in the phenomenon being measured usually has a negligible effect on the excitation strength. One exception is if the phenomenon being measured changes its frequency band of variation. For example, consider a sensor measuring strain on a structure. It measures an oscillation in the range of 1 to 2 Hz, which is the natural harmonic frequency of the structure. Then a change is made to the structure to stiffen it so that the natural frequency is now 10 to 20 Hz. When this happens, more energy is dissipated in the sensor as variations occur faster. So, even though the mean value of the strain in the sensor did not change, more energy (higher excitation strength) is required to produce the signal.

9.7.5 Frequency filters

9.7.5.1 Harmonics	39
9.7.5.2 Estimated frequency range	39
9.7.5.3 Actual frequency range	39

9.7.5.1 Harmonics

Some sensors have very strong harmonics that can exceed the amplitude of the fundamental resonant frequency; this results in measurement error. You can eliminate harmonics by adjusting the frequency boundaries. By putting the harmonic outside the range of allowed frequencies, it is eliminated as a source of error. Also, spurious noise sources can be excluded from the measurement range by selecting appropriate range boundaries.

If adjusting frequency boundaries does not reduce error, force the VWIRE 305 to re-assess the primary frequency by either disabling then re-enabling the input channel or by resending the CRBasic program to the data logger.

9.7.5.2 Estimated frequency range

The VWIRE 305 filters unwanted frequencies, such as harmonics, from vibrating wire output using the operator-entered low-frequency boundary and high-frequency boundary. The range bounded by these estimates is the estimated-frequency range. Enter boundary estimates into *DVW Toolbox* **low-frequency boundary** and **high-frequency boundary** columns or CRBasic [CDM_VW300\(\)](#) instruction **LowFreq** and **HighFreq** parameters. The best source for boundary estimates is the sensor manufacturer — perhaps in a calibration report.

9.7.5.3 Actual frequency range

Due to the mathematical constraints of the algorithms, the VWIRE 305 cannot usually comply with the exact boundary values specified by the user. It establishes the actual-frequency range, which is bounded by the actual-low frequency and actual-high frequency. Boundary values are excluded from the frequency ranges.

[FIGURE 9-4](#) (p. 40) shows how boundaries and ranges relate to each other:

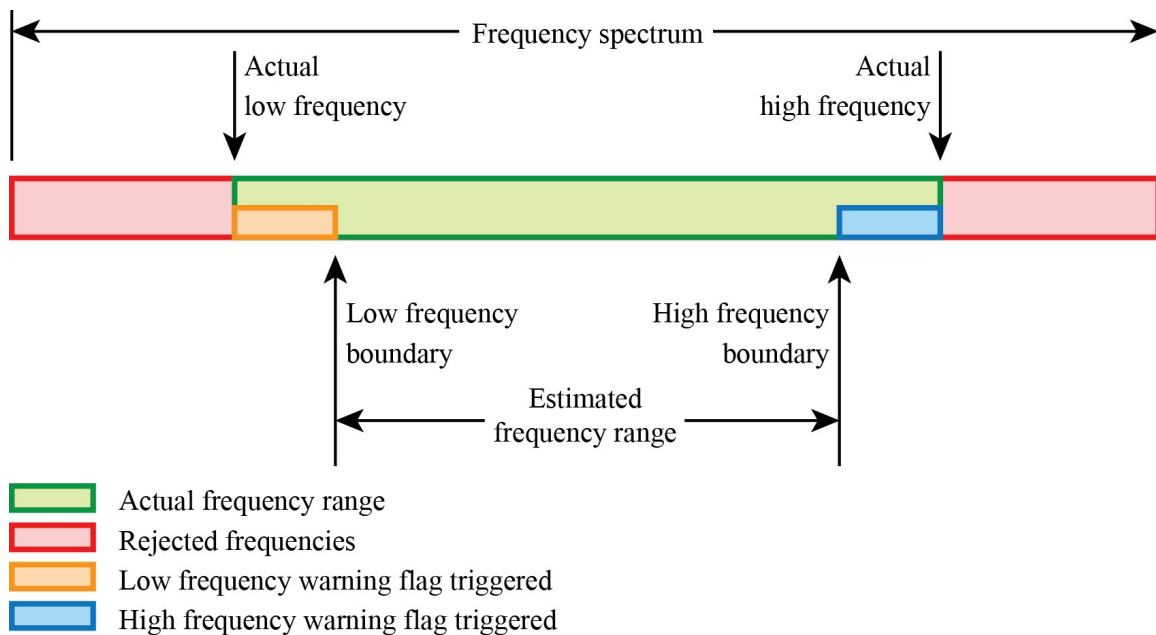

FIGURE 9-4. Relationship of estimated- and actual-frequency ranges and frequency warning flags

The actual range is equal in size or larger than the estimated range. If you wish to know the actual boundaries, in *DVW Toolbox*, click on **View > Advanced**. Two new columns, **Actual Low Frequency** and **Actual High Frequency**, appear on the main window.

If using *DVW Toolbox* is not practical, you can calculate the actual boundaries. Calculate the actual-frequency range using boundary resolution value in the fourth column of [Table 9-1](#) (p. 23) as a reference. For example, if the data logger scan interval is set to 500 ms, the VWIRE 305 sample rate is 20 Hz and its boundary resolution is 47.68 Hz. If you estimate the low-frequency boundary at 150 Hz, the nearest multiple of 47.68 Hz that is less than the estimate is 143.04 Hz ($3 \cdot 47.68$ Hz). Enter **143.04** into **low-frequency boundary** in *DVW Toolbox* or **LowFreq** in CRBasic. Likewise, if you estimate the high-frequency boundary at 500 Hz, the nearest multiple of 47.68 Hz that is more than the estimate is 476.80 ($10 \cdot 47.68$ Hz). Enter **476.80** into **high-frequency boundary** in *DVW Toolbox* or **LowFreq** in the CRBasic program.

Matching estimated and actual frequency ranges

Minimize the difference between the estimated-frequency range and the actual-frequency range by entering the actual frequency values as the low-frequency boundary and high-frequency boundary. However, there are benefits to not having the estimated-frequency range match the actual-frequency range. The VWIRE 305 issues warning flags if the measured frequency falls in the gaps between the two ranges.

9.7.6 Frequency warning flags

Frequency warning flags are triggered at the following times:

- When a resonant frequency falls between the estimated- and actual-frequency ranges. This may indicate a change in the output of a sensor before the output moves outside the actual-frequency range. See [FIGURE 9-4](#) (p. 40).
- When the low-frequency boundary or high-frequency boundary is set outside the range allowed by the selected sample rate.
- When the Sample Rate setting is invalid for the resonant frequency. See [Table 9-2](#) (p. 24).

For example, at the VWIRE 305 sample rate of 100 Hz, the VWIRE 305 can measure frequencies anywhere from 580 to 6000 Hz. A resonant frequency outside this range will trigger a flag. Furthering this example, if signal frequencies output by the sensor always fall between 2000 and 3000 Hz, you can set the low-frequency boundary to 2000 Hz and the high-frequency boundary to 3000 Hz. The VWIRE 305 will adjust the boundaries to 1907.3 Hz and 3051.68. If a measurement falls between 1907.3 and 2000, a low-frequency warning flag is raised. If a measurement falls between 3000 and 3051.68, a high frequency warning flag is raised.

See [Diagnostic codes](#) (p. 36) for further discussion of warning flags and how they are tagged to a measurement.

9.7.7 Sample rate and noise performance

Electrical noise limits the effective resolution, or precision, of a vibrating wire measurement. To increase precision, decrease the measurement sample rate. The fifth column of [Table 9-1](#) (p. 23) lists the noise level associated with each sample rate.

Other topics that discuss noise performance are found in the following sections:

- [Static measurement](#) (p. 7)
- [Frequency filters](#) (p. 38)
- [VSPECT measurement theory](#) (p. 49)
- [Calculating vibrating wire measurement error](#) (p. 52)

9.7.8 Standard deviation

The `CDM_VW300Static()` instruction has an option to output a 1 Hz calculation of the standard deviation of the dynamic readings. If the standard deviation changes significantly, spend time to figure out what is causing the change. Significance of change depends on the application. For example, a significant increase from a baseline (be sure to determine and record a baseline when first installing a station) may indicate a problem with the sensor or a significant shift in the structure or phenomenon being measured.

9.8 Sensors

Vibrating wire sensors come in many varieties for many applications, but they all have the same basic design features and fundamentals of operation. When choosing a sensor, beside the form and fit, the basic fundamentals of operation affect how well your sensor performs with the VWIRE 305.

9.8.1 Sensor basic design features

Vibrating wire sensors have the following components, which are illustrated in [FIGURE 9-5](#) (p. 42):

- Sensing element
- Taut wire attached to sensing element
- Plucking and pickup coils
- Optional thermistor or RTD
- Two coil input/outputs
- Two thermistor input/outputs

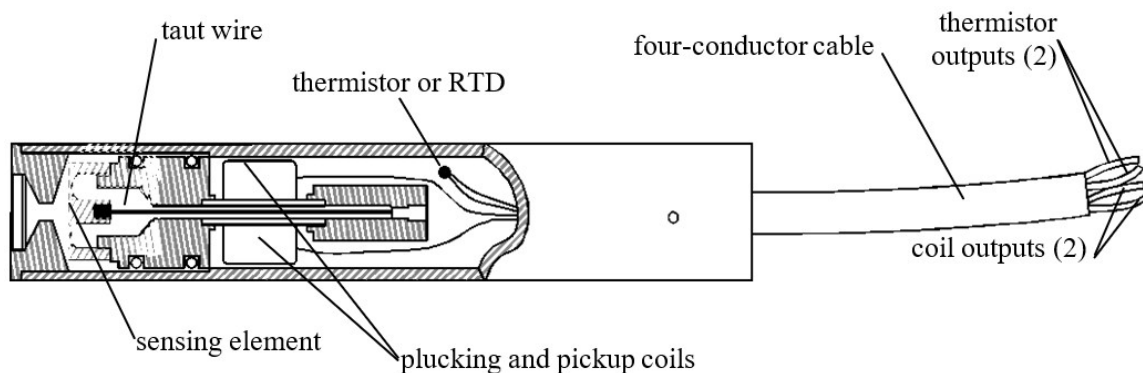

FIGURE 9-5. Basic design features of a vibrating wire sensor

9.8.2 Basic measurement of the sensor

The VWIRE 305 applies excitation and measures the return vibrating wire signal on the plucking and pickup coil wires. It applies excitation and measures the return temperature signal on the thermistor wires.

9.8.3 Vibrating wire length and tension

Vibrating wire sensors vibrate within a discrete frequency-output range that is determined by the manufacturer. The frequency of the vibration is a function of two factors: the length of the wire and the tension of the wire.

Length is fixed because that is how the sensor is built. Tension, however, changes as the environment around the sensor changes. For example, the wire in a pressure sensor is attached at one end to a diaphragm. As the diaphragm flexes with changes in external pressure, the wire is stretched or relaxed. The stretch or relaxation is proportional to external pressure.

Depending on the purpose of the sensor, the manufactured lengths of vibrating wires vary widely. Shorter wires vibrate at higher frequencies, longer wires at lower frequencies. For example, one to two inch gages vibrate near 3000 Hz, while six inch gages vibrate near 900 Hz.

9.8.4 Sensor output frequency range and maximum sample rate

Higher VWIRE 305 sampling rates require higher and tighter sensor frequency-output ranges. The vibrating wire in a sensor must vibrate five to 10 times per measurement for the VWIRE 305 to pick it up. Longer gages, such as those that vibrate near 900 Hz, cannot be measured at higher VWIRE 305 scan rates because the wire does not vibrate fast enough to get the required number of vibrations for a measurement.

As a general rule, the fastest that a vibrating wire gage can be measured is approximately 20 percent of the resonant frequency. For example, a gage that resonates at about 1100 Hz can be measured at a maximum of 20 % of 1100 Hz, or at 220 Hz, so the **200 Hz** measurement range is used.

The third column of [Table 9-1](#) (p. 23) lists the sensor frequency-output ranges that can be measured at the VWIRE 305 sample rates.

Some applications may require that a sensor be used that can be sampled over a wide range of sample rates. Sensors with higher resonant frequencies are more versatile. For example, as shown in the previous table, a sensor with a resonant frequency of 2000 Hz can be measured at scan rates 20, 50, 100, 200, and 333.3 Hz. On the other hand, a sensor with a resonant frequency of 290 Hz can be measured only at 20 or 50 Hz.

9.8.5 Temperature sensor

[FIGURE 9-5](#) (p. 42) shows the location of the temperature sensor. Sensor manufacturers have many thermistors and RTDs to choose from, so this manual has only general guidelines about measuring an embedded temperature sensor. Additional information is in [Measuring thermistors and PRTs](#) (p. 55).

Be aware that some manufacturers, Slope Indicator, for example, use different thermistors or RTDs in the same model of sensor according to what the client orders. Take this into consideration when specifying and ordering sensors.

Procedure:

1. Do the procedure in [Quickstart](#) (p. 2).
2. If there are values other than zero in the *DVW Toolbox* **Steinhart-Hart Coefficients A, B, and C** columns for the sensor, write these down because you may need them later.
3. Set **Steinhart-Hart Coefficients A, B, and C** to 0.
4. Connect one wire from the temperature sensing element (it does not matter which one) to either of the **T** terminals of the same input channel to which you connected the vibrating wire sensor. Connect the other wire to the other **T** terminal. You should immediately see a resistance value in the **Static Thermistor** column of *DVW Toolbox*. This is the resistance value of the temperature sensing element. It is expressed in ohms (Ω). Check this resistance against the documentation that came with your sensor to confirm that the correct resistance is displayed for the current temperature.
5. Convert the measured resistance to temperature:
 - If the temperature sensing element is a thermistor, do the following:
 - Enter the Steinhart-Hart coefficients provided by the manufacturer into the **Steinhart-Hart Coefficients A, B, and C** columns. The value in the **Static Thermistor** column should now be the current temperature expressed in degrees Celsius. For DGS1 sensors, our **C** coefficient equals their **D** coefficient.
 - Set up the VWIRE 305 to convert the resistance to temperature by entering the Steinhart-Hart coefficients into VWIRE 305 settings using *DVW Toolbox*, *Device Configuration Utility*, or a program created with *CRBasic Editor*.
 - If the element is an RTD, do the following:
 - Some sensors use PRTs instead of thermistors. If your sensor is a PRT, find the Calendar-Van Dusen coefficients on the sensor calibration sheet.
 - Add code to the program created with *CRBasic Editor* to convert resistance to temperature. The PT100 PRT discussion in Campbell Scientific data logger manuals may help you do this.
 - The other option for both thermistors and PRTs is to simply store the resistance data then convert resistance to temperature on a computer after collecting data from the field.

TIP:

It is good practice to preserve the original vibrating wire measurements when converting them to temperature compensated values.

Convert the original vibrating wire measurements to temperature compensated measurements by adding code to the data logger program, or by calculating the compensation on a computer after data are collected from the field. For either option, you need to get the compensation equation and factors from the sensor manufacturer. These may be on the sensor calibration sheet.

9.9 Status of input channels and sensors

The status of VWIRE 305 input channels and the sensors connected to them can be determined by interpreting the state of the **Channel Status** lights. The following table summarizes the interpretation of these states.

Light state	Channel status
Flashing red or green at 3 s interval	Channel enabled
Flashing green	Channel enabled; sensor active; measurements within set ranges
Flashing red	Channel is enabled; sensor is active; some measurements are outside set range(s), so diagnostic warning flag(s) is True .
Dark; not flashing	Channel disabled

10. Troubleshooting

1. Check the voltage of the power source at the **Power** connector. It should be between 9.6 and 32 VDC.
2. Check wires and cables for the following:
 - Loose connection points
 - Faulty connectors
 - Cut wires
 - Damaged insulation, which allows water to migrate into the cable. Water, whether or not it comes in contact with wire, can cause system failure. Water may increase the

dielectric constant of the cable sufficiently to impede sensor signals, or it may migrate into the sensor, which will damage sensor electronics.

3. Check the CRBasic program. Create a simplified version of the program, or break it up into multiple smaller units to test individually. For example, if a sensor signal-to-data conversion is faulty, create a program that only measures that sensor and stores the data, absent from all other inputs and data. Write these mini-programs before going to the field, if possible.
4. Verify that each VWIRE 305 in the network has a unique CPI address.
5. Check the data logger and VWIRE 305 operating system and update them as needed.
6. Check that the scan rate is long enough for the measurement time. The data logger compiler often catches scan rates that are too fast.
7. Ensure that the CPI network bit rate is fast enough for the data generated and that it can accommodate the cable lengths in use. (See [CPI network bit rate](#) (p. 32).)

10.1 CPIStatus table

Information in the **CPIStatus** table, located in the data logger, helps in troubleshooting. The **ModuleInfo()** array shows the following information:

CDM Type, Serial Number, Device Name, CPI Address, Activity

The last entry in the **ModuleInfo()** index shows the activity of the module. Possible entries and their meanings are shown in the following table.

Response	Meaning
Active	The module is connected to the CPI bus and is making measurements according to the data logger program.
Offline	The module was present after startup but is no longer responding.
Unused	The module is or was connected and powered but is not included in the data logger program.
Wait Config	The module has not yet responded to a data logger's attempts to configure it.
Config Fail	The module could not be configured. A configuration error message is appended to this response.

10.2 COMM status LED

The COMM status LED indicates the current operation of the VWIRE 305, as shown in the following table..

Table 10-2: COMM Status LED Activity		
Green	Flashing	Module has been configured by data logger and is receiving sync signals
Regular red/green cycle	Flashing	Too many channels or analyzers for the configuration.
Green and Red	Flashing	CPI network initializing.
Red	Flashing	Power lost to CPI network but VWIRE 305 is still powered or CPI speed mismatch.
Yellow	Flashing	VWIRE 305 powered but not connected to CPI network.

10.3 CPI port LEDs

Green and Orange LEDs on the CPI bus indicate the current operation of the CPI bus as shown in the following table.

Table 10-3: CPI port LED activity		
Green	Flashing	Frame sync
Orange	Flash	CPI activity
	Solid	CPI bus fault

10.4 Replacing a GRANITE Measurement Module

An existing VWIRE 305 can be replaced with a new module using the same CPI address without requiring a change to the program.

11. References and attributions

Matsuishi, M. and T. Endo.: 1968, "Fatigue of Metals Subjected to Varying Stress." *J. of the Japan Society of Mechanical Engineers*, Fukuoka, Japan, 37–40.

Jacobsen, L.E., D.L. Israelsen, J.A. Swenson, "Vibrating Wire Sensor Using Spectral Analysis", *U.S. Patent 7779690*, August 24, 2010.

Jacobsen, L.E. and S.S. Cornelsen, "System And Method For Measuring The Frequency Of A Vibrating Object." *U.S. Patent 8671758*, March 18, 2014.

Madsen, C., S. Cornelsen, "Designing Physical Network Layouts for the CPI Bus", Campbell Scientific, Inc, March 20, 2014.

Appendix A. VSPECT measurement theory

In a vibrating wire sensor, the coil serves the following functions:

- Actuator to put energy into the wire
- Pickup to detect the motion of the wire

The resonant frequency of a vibrating wire cannot be measured at static rates faster than about 1 Hz. A static measurement excites the wire and measures the response. Excitation is a swept frequency sine wave that supplies a broad spectrum of frequencies to the wire. If you listen closely to most vibrating wire sensors, during a static measurement you can hear tones ascending through the swept frequency excitation. Time is then required for the non-resonant frequencies to die out, and then more time is needed to sample the resonant frequency. Additional time is required for the resonant frequency to die out before the next excitation/measurement cycle begins.

In contrast, the VWIRE 305 makes dynamic measurements at rates as high as 333.3 Hz. The key difference in the dynamic method versus the static method is that the wire is maintained in a continuously vibrating state. The dynamic process eliminates the swept frequency sine wave. Instead, the VWIRE 305 injects energy into the oscillation at just the right frequency and phase, so a very short excitation with small amplitude maintains wire resonance. Phase alignment of excitation strengthens wire resonance and decreases measurement noise.

The system synchronizes all measurement channels to the data logger clock through the CRBasic program and CPI bus. Synchronization has the added benefit of allowing for simultaneous sampling of channels, so there is good measurement correlation across multiple sensors and multiple modules. Synchronized excitation is a key difference between dynamic VSPECTTM measurements and other auto-resonant excitation schemes.

To improve dynamic measurements, the VWIRE 305 measures a static frequency at 1 Hz and uses it as a reference in noise rejection. Since the VWIRE 305 samples only a few cycles of the wire each time it makes a dynamic measurement, the spectral resolution is coarser than when using all captured data. As a result, occasional noise frequencies are gathered into the same FFT (Fast Fourier Transform) bin as those of the signal, which causes measurement error. The VWIRE 305 measures the static frequency at a finer resolution to detect the noise and prompt you to take corrective action.

Appendix B. Vibrating wire digits conversion

Manufacturers usually include calibration data with vibrating wire sensors. Use the data to convert frequency to a unit of measure.

The VWIRE 305 is usually set up to measure frequency in units of Hertz (Hz), but some calibration sheets report data in units of **digits** or **B units**. If this is the case with your sensor, convert **Hertz** to digits with the following formula:

$$\text{digits or B units} = \text{Hz}^2 / 1000$$

Use the gage factor and polynomial from the sensor calibration sheet to convert to units of measure.

Using the calibration report shown in [FIGURE B-1](#) (p. 51), the following example converts frequency to displacement:

For example, the VWIRE 305 measures a displacement sensor and reports a frequency of 2400 Hz. The relationship of sensor output to displacement, s , is expressed in the calibration report as follows:

$$s = (9.139\text{E}-08) \times \text{digits}^2 + (0.03054) \times \text{digits} + (-80.471)$$

The conversion procedure follows:

1. Convert hertz to digits:

$$\text{digits} = (2400 \text{ Hz})^2 / 1000 = 5760$$

2. Convert digits to displacement:

$$s = (9.139\text{E}-08) \times (5760)^2 + (0.03054) \times 5760 + (-80.471)$$

$$s = 98.47 \text{ mm}$$

Vibrating Wire Displacement Transducer Calibration Report

Range: 150 mm Calibration Date: January 7, 2010
 Serial Number: 0939696 Temperature: 23.4 °C
 Calibration Instruction: CI-4400
 Technician: _____
 GK-401 Reading Position B

Actual Displacement (mm)	Gage Reading 1st Cycle	Gage Reading 2nd Cycle	Average Gage Reading	Calculated Displacement (Linear)	Error Linear (%FS)	Calculated Displacement (Polynomial)	Error Polynomial (%FS)
0.0	2614	2613	2614	-0.30	-0.20	-0.03	-0.02
30.0	3580	3579	3580	30.08	0.05	30.03	0.02
60.0	4539	4539	4539	60.26	0.18	60.04	0.03
90.0	5492	5489	5491	90.19	0.13	89.98	-0.02
120.0	6437	6439	6438	120.00	0.00	119.95	-0.04
150.0	7385	7383	7384	149.76	-0.16	150.03	0.02

(mm) Linear Gage Factor (G): 0.03146 (mm/ digit) Regression Zero: 2623

Polynomial Gage Factors: A: 9.139E-08 B: 0.03054 C: -80.471

(inches) Linear Gage Factor (G): 0.001238 (inches/ digit)

Polynomial Gage Factors: A: 3.598E-09 B: 0.001202 C: -3.1682

Calculated Displacement: Linear, $D = G(R_1 - R_0)$

Polynomial, $D = AR_1^2 + BR_1 + C$

Refer to manual for temperature correction information.

Function Test at Shipment:

GK-401 Pos. B : 4239 Temp(T_0): 24.1 °C Date: January 28, 2010

The above instrument was found to be in tolerance in all operating ranges.

The above instrument was found to be in tolerance in all operating ranges.

The above named instrument has been calibrated by comparison with standards traceable to the NIST, in compliance with ANSI Z540-1.

This report shall not be reproduced except in full without written permission of Geokon Inc.

FIGURE B-1. Geokon calibration report

Appendix C. Calculating vibrating wire measurement error

The fundamental measurement of the VWIRE 305 is frequency, f .

Wire tension is the square of the resonant frequency (f^2). The calibration report from the sensor manufacturer provides a formula for converting frequency, f , to the target unit of measure, U_E , as follows:

$$U_E = Kf^2 \quad \text{Eq. 1}$$

K is the calibration constant.

For a very small change in frequency, Δf , change in U_E , ΔU_E , is expressed as follows:

$$\Delta U_E = 2Kf\Delta f \quad \text{Eq. 2}$$

Eq. 2 (p. 52) is the first derivative of Eq. 1 (p. 52) with respect to f .

Effective resolution of a measurement, R_e , is calculated using Eq. 2 (p. 52) and a noise level, N . Values for N are found in the fifth column of [VWIRE 305 sample rates and specifications](#) (p. 23). For a specific VWIRE 305 scan rate, use the corresponding N value in place of Δf . Eq. 2 (p. 52) is then expressed as follows:

$$R_e = 2KfN \quad \text{Eq. 3}$$

C.1 Error example: Geokon strain gage

K is calculated as follows:

$$K = GB / 1000$$

G is gage factor 4.062 or 0.391, depending on gage type. B is the batch factor, which is usually a number within a few hundredths of 1. These values are found on documentation provided by the sensor manufacturer.

Microstrain:

$$\mu\epsilon = GBf^2 / 1000$$

Effective resolution, (R_e):

$$R_e = \Delta\mu\epsilon$$

$$\Delta\mu\epsilon = 2\text{GBfN} / 1000$$

$$\Delta\mu\epsilon = \text{GBfN} / 500$$

N is the noise level given in [VWIRE 305 sample rates and specifications](#) (p. 23) corresponding to the VWIRE 305 scan rate being used.

C.2 Error example: DGSI embedment strain gage

$$K = G$$

$$G = 4.0624\text{E}-03$$

Microstrain:

$$\mu\epsilon = Gf^2$$

Effective resolution, (R_e):

$$R_e = \Delta\mu\epsilon$$

$$\Delta\mu\epsilon = 2GfN$$

C.3 Error example: DGSI spot-welded strain gage

Microstrain:

$$\mu\epsilon = Af^2 + C$$

$$A = 7.576\text{E}-04 \text{ and } C = -2030.1$$

So, $K = A$.

For effective resolution, C does not vary with frequency, so it can be ignored for very small changes in frequency.

Effective resolution, (R_e):

$$R_e = \Delta\mu\epsilon$$

$$\Delta\mu\epsilon = 2AfN$$

C.4 Error example: Geokon 4420 crack meter

Displacement (s):

$$s = (Gf^2 / 1000) + Kt$$

G = linear gage factor

K= thermal factor

t= temperature of the sensor

During a short measurement interval, assume no change in sensor temperature. So, for small changes in sensor displacement, K is assumed to be constant, and the Kt term is ignored when calculating the output error:

$$\Delta s = 2GfN / 1000$$

$$\Delta s = GfN / 500$$

C.5 Error example: DGSI piezometer 52611099

Pressure:

$$P = Af^2 + Bf + C$$

A, B, and C are gage factors.

Effective resolution:

$$R_e = \Delta P$$

$$\Delta P = (2Af + B)N$$

$$\Delta P = 2AfN + BN$$

Appendix D. Measuring thermistors and PRTs

Vibrating wire sensors may include an embedded thermistor or PRT (platinum resistance thermometer).

D.1 Converting PRT resistance to temperature

The VWIRE 305 analyzer does not support direct PRT measurement conversion to temperature, but it does measure PRT resistance. You can add lines of code to the CRBasic data logger program to convert PRT resistance to temperature, or you can convert the resistance as part of a post-processing operation in a spread sheet or other software. You will need to get PRT conversion factors from the sensor manufacturer.

D.2 Converting thermistor resistance to temperature

Convert resistance of most thermistors using the Steinhart-Hart equation as follows:

$$^{\circ}\text{C} = 1 / (A + B(\ln(R)) + C(\ln(R))^3) - 273.15$$

Where $\ln(R)$ is the natural log of the resistance measurement and A, B, and C are Steinhart-Hart equation coefficients. Each thermistor type has unique coefficients. Sensor manufacturers provide the coefficients. Our C coefficient is DGS's D coefficient.

Example:

The Steinhart-Hart coefficients for the thermistor embedded in a standard Geokon vibrating wire sensor are as follows:

$$A = 1.4051\text{E}-03$$

$$B = 2.369\text{E}-04$$

$$C = 1.019\text{E}-07$$

The Steinhart-Hart equation to convert thermistor resistance to degrees Celsius is as follows:

$$^{\circ}\text{C} = 1 / (1.4051\text{E}-03 + 2.369\text{E}-04(\ln(R)) + 1.019\text{E}-07(\ln(R))^3) - 273.15$$

If R is 2221 Ω , temperature is calculated as follows:

$$^{\circ}\text{C} = 1 / (1.4051\text{E}-03 + 2.369\text{E}-04(\ln(2221)) + 1.019\text{E}-07(\ln(2221))^3) - 273.15$$

$$^{\circ}\text{C} = 31.98$$

D.2.1 Thermistor measurement accuracy and resolution

Accuracy of a thermistor temperature measurement is a function of the following factors listed in order of importance:

1. Thermistor interchangeability
2. Change in cable resistance
3. Cable resistance
4. Steinhart-Hart equation error
5. Precision of the bridge resistors
6. Accuracy of the data logger voltage measurement
7. Temperature coefficient of the bridge resistors

Factor 1, interchangeability, expresses how tightly sensing elements of the same type conform to the ideal. Deviations from the ideal are caused by slight manufacturing differences. Thermistor manufacturers do not calibrate each thermistor produced. Instead, each thermistor is manufactured to meet the ideal within certain tolerances. For example, the Measurement Specialties 100K6A1iA thermistor is manufactured to be within ± 0.10 $^{\circ}\text{C}$ of the ideal at 0 to 50 $^{\circ}\text{C}$. So, one 100K6A1iA thermistor can be interchanged with another. Each thermistor will measure within ± 0.10 $^{\circ}\text{C}$ of the ideal.

Factor 2 is primarily caused by changes in cable temperature. Increase in temperature causes an increase in cable resistance. Increase in cable resistance passes into the measurement as an increase in thermistor or PRT resistance. [FIGURE D-1](#) (p. 57) shows how wire resistance affects the temperature measurement for a Geokon 4500 vibrating wire piezometer. The vibrating wire measurement is not affected significantly by cable temperature, but the temperature measurement is affected slightly.

If the vibrating wire measurement is temperature corrected, then Factor 2 does affect the vibrating wire measurement. For this reason, in applications where temperature measurement errors must be minimized, the sensor cable should be shielded from the sun and other sources of significant thermal potential, hot or cold.

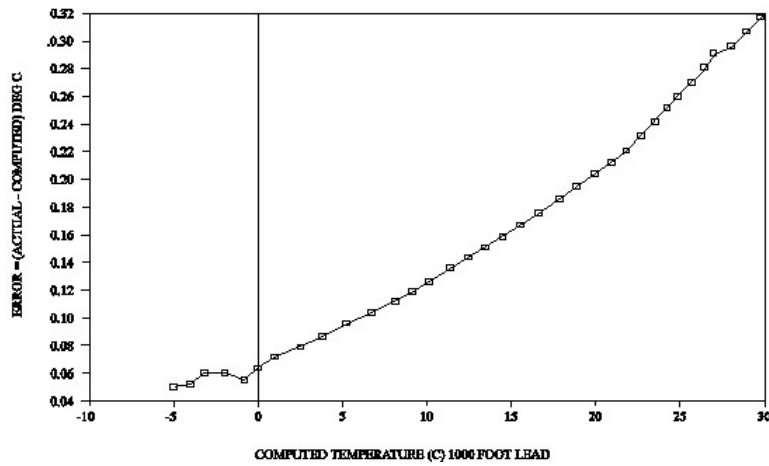

FIGURE D-1. Temperature-induced measurement error on a 1000 foot cable. Wire is 22 AWG, 16 Ω per 1000 feet.

Factor 3, cable resistance, is primarily an offset error and is usually removed by the sensor manufacturer's initial calibration. FIGURE D-2 (p. 57) emphasizes the importance of removing offset by showing how offsets due to cable length influence measurement error. Offset correction is valid if cable length and type are not altered from that received from the manufacturer.

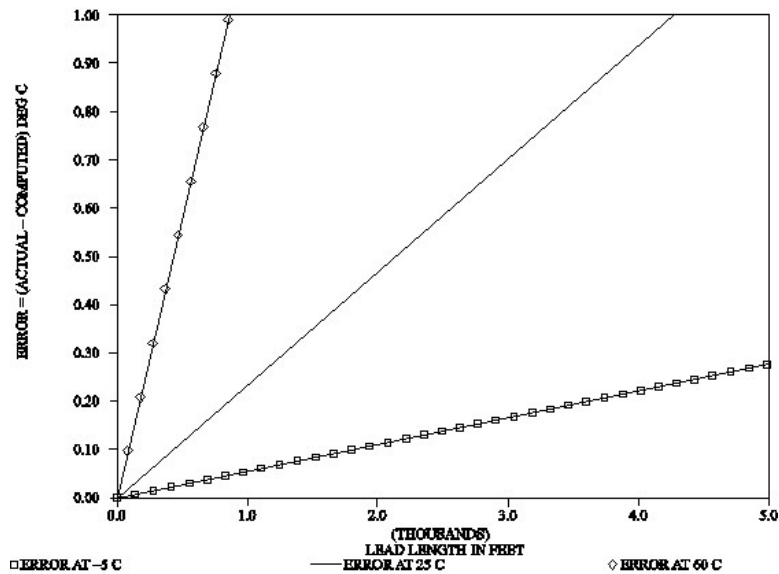

FIGURE D-2. Temperature error offsets at three temperatures as a function of cable length. Wire is 22 AWG, 16 Ω per 1000 feet.

Factors 4 through 7 are usually very small and ignored.

Appendix E. Example programs

These programs were written for a GRANITE 6 data logger, except where noted. With slight modifications, they can be used with other Campbell Scientific data loggers.

NOTE:

For the GRANITE 10 and GRANITE 9 data loggers, the `CPIBusAddress` parameter must include the CPI bus when using bus B. Bus A is the default. For example, `CPI_BusB + 2` specifies CPI bus B and CPI address 2.

E.1 Configuring GRANITE Measurement Module with `CPIAddModule()`

The following program sets CPI addresses and device names on VWIRE 305s with serial numbers 2213, 2207, and 2206 and makes both dynamic and static measurements on each sensor on each module.

NOTE:

This is not a complete program. The VWIRE 305 needs additional configuration using `CDM_Vw300Config()`.

CRBasic Example 1: Using CPIAddModule()

'GRANITE 6 Datalogger

'This program sets CPI addresses and device names of three VWIRE 305s.

NOTE: This is not a complete program. See

<https://www.campbellsci.com/downloads/vwire-example>  *for a complete example program.*

```
Public PTemp
Public Freq_1, Diag_1
Public Freq_2, Diag_2
Public Freq_3, Diag_3
Public StaticFreq_1, Therm_1, StrainStdDev_1
Public StaticFreq_2, Therm_2, StrainStdDev_2
Public StaticFreq_3, Therm_3, StrainStdDev_3
```

CDM_VW300Config() See [VWIRE 305 programming](#) (p. 34) for more information.

'Main Program

BeginProg

```
CPIAddModule (VWIRE305,2213,"VWIRESN2213",1)
CPIAddModule (VWIRE305,2207,"VWIRESN2207",2)
CPIAddModule (VWIRE305,2206,"VWIRESN2206",3)
```

```
Scan (50,mSec,0,0)
```

```
PanelTemp (PTemp,15000)
CDM_VW300Dynamic(1, Freq_1(), Diag_1())
CDM_VW300Dynamic(2, Freq_2(), Diag_2())
CDM_VW300Dynamic(3, Freq_3(), Diag_3())
```

```
If TimeIntoInterval(0,1,Sec) Then 'Process static data only once per second
```

```
'Get static data
```

```
CDM_VW300Static(1, StaticFreq_1(), Therm_1(), StrainStdDev_1())
CDM_VW300Static(2, StaticFreq_2(), Therm_2(), StrainStdDev_2())
CDM_VW300Static(3, StaticFreq_3(), Therm_3(), StrainStdDev_3())
```

```
EndIf
```

```
NextScan
```

```
EndProg
```

Limited warranty

Products manufactured by Campbell Scientific are warranted by Campbell Scientific to be free from defects in materials and workmanship under normal use and service for twelve months from the date of shipment unless otherwise specified on the corresponding product webpage. See Product Details on the Ordering Information pages at www.campbellsci.com[↗]. Other manufacturer's products, that are resold by Campbell Scientific, are warranted only to the limits extended by the original manufacturer.

Refer to www.campbellsci.com/terms#warranty[↗] for more information.

CAMPBELL SCIENTIFIC EXPRESSLY DISCLAIMS AND EXCLUDES ANY IMPLIED WARRANTIES OF MERCHANTABILITY OR FITNESS FOR A PARTICULAR PURPOSE. Campbell Scientific hereby disclaims, to the fullest extent allowed by applicable law, any and all warranties and conditions with respect to the Products, whether express, implied or statutory, other than those expressly provided herein.

Assistance

Products may not be returned without prior authorization.

Products shipped to Campbell Scientific require a Returned Materials Authorization (RMA) or Repair Reference number and must be clean and uncontaminated by harmful substances, such as hazardous materials, chemicals, insects, and pests. Please complete the required forms prior to shipping equipment.

Campbell Scientific regional offices handle repairs for customers within their territories. Please see the back page for the Global Sales and Support Network or visit www.campbellsci.com/contact  to determine which Campbell Scientific office serves your country.

To obtain a Returned Materials Authorization or Repair Reference number, contact your CAMPBELL SCIENTIFIC regional office. Please write the issued number clearly on the outside of the shipping container and ship as directed.

For all returns, the customer must provide a "Statement of Product Cleanliness and Decontamination" or "Declaration of Hazardous Material and Decontamination" form and comply with the requirements specified in it. The form is available from your CAMPBELL SCIENTIFIC regional office. Campbell Scientific is unable to process any returns until we receive this statement. If the statement is not received within three days of product receipt or is incomplete, the product will be returned to the customer at the customer's expense. Campbell Scientific reserves the right to refuse service on products that were exposed to contaminants that may cause health or safety concerns for our employees.

Safety

DANGER — MANY HAZARDS ARE ASSOCIATED WITH INSTALLING, USING, MAINTAINING, AND WORKING ON OR AROUND **TRIPODS, TOWERS, AND ANY ATTACHMENTS TO TRIPODS AND TOWERS SUCH AS SENSORS, CROSSARMS, ENCLOSURES, ANTENNAS, ETC.** FAILURE TO PROPERLY AND COMPLETELY ASSEMBLE, INSTALL, OPERATE, USE, AND MAINTAIN TRIPODS, TOWERS, AND ATTACHMENTS, AND FAILURE TO HEED WARNINGS, INCREASES THE RISK OF DEATH, ACCIDENT, SERIOUS INJURY, PROPERTY DAMAGE, AND PRODUCT FAILURE. TAKE ALL REASONABLE PRECAUTIONS TO AVOID THESE HAZARDS. CHECK WITH YOUR ORGANIZATION'S SAFETY COORDINATOR (OR POLICY) FOR PROCEDURES AND REQUIRED PROTECTIVE EQUIPMENT PRIOR TO PERFORMING ANY WORK.

Use tripods, towers, and attachments to tripods and towers only for purposes for which they are designed. Do not exceed design limits. Be familiar and comply with all instructions provided in product manuals. Manuals are available at www.campbellsci.com. You are responsible for conformance with governing codes and regulations, including safety regulations, and the integrity and location of structures or land to which towers, tripods, and any attachments are attached. Installation sites should be evaluated and approved by a qualified engineer. If questions or concerns arise regarding installation, use, or maintenance of tripods, towers, attachments, or electrical connections, consult with a licensed and qualified engineer or electrician.

General

- Protect from over-voltage.
- Protect electrical equipment from water.
- Protect from electrostatic discharge (ESD).
- Protect from lightning.
- Prior to performing site or installation work, obtain required approvals and permits. Comply with all governing structure-height regulations.
- Use only qualified personnel for installation, use, and maintenance of tripods and towers, and any attachments to tripods and towers. The use of licensed and qualified contractors is highly recommended.
- Read all applicable instructions carefully and understand procedures thoroughly before beginning work.
- Wear a **hardhat** and **eye protection**, and take **other appropriate safety precautions** while working on or around tripods and towers.
- **Do not climb** tripods or towers at any time, and prohibit climbing by other persons. Take reasonable precautions to secure tripod and tower sites from trespassers.
- Use only manufacturer recommended parts, materials, and tools.

Utility and Electrical

- **You can be killed** or sustain serious bodily injury if the tripod, tower, or attachments you are installing, constructing, using, or maintaining, or a tool, stake, or anchor, come in **contact with overhead or underground utility lines**.
- Maintain a distance of at least one-and-one-half times structure height, 6 meters (20 feet), or the distance required by applicable law, **whichever is greater**, between overhead utility lines and the structure (tripod, tower, attachments, or tools).
- Prior to performing site or installation work, inform all utility companies and have all underground utilities marked.
- Comply with all electrical codes. Electrical equipment and related grounding devices should be installed by a licensed and qualified electrician.
- Only use power sources approved for use in the country of installation to power Campbell Scientific devices.

Elevated Work and Weather

- Exercise extreme caution when performing elevated work.
- Use appropriate equipment and safety practices.
- During installation and maintenance, keep tower and tripod sites clear of un-trained or non-essential personnel. Take precautions to prevent elevated tools and objects from dropping.
- Do not perform any work in inclement weather, including wind, rain, snow, lightning, etc.

Maintenance

- Periodically (at least yearly) check for wear and damage, including corrosion, stress cracks, frayed cables, loose cable clamps, cable tightness, etc. and take necessary corrective actions.
- Periodically (at least yearly) check electrical ground connections.

Internal Battery

- Be aware of fire, explosion, and severe-burn hazards.
- Misuse or improper installation of the internal lithium battery can cause severe injury.
- Do not recharge, disassemble, heat above 100 °C (212 °F), solder directly to the cell, incinerate, or expose contents to water. Dispose of spent batteries properly.

WHILE EVERY ATTEMPT IS MADE TO EMBODY THE HIGHEST DEGREE OF SAFETY IN ALL CAMPBELL SCIENTIFIC PRODUCTS, THE CUSTOMER ASSUMES ALL RISK FROM ANY INJURY RESULTING FROM IMPROPER INSTALLATION, USE, OR MAINTENANCE OF TRIPODS, TOWERS, OR ATTACHMENTS TO TRIPODS AND TOWERS SUCH AS SENSORS, CROSSARMS, ENCLOSURES, ANTENNAS, ETC.



Global Sales & Support Network

A worldwide network to help meet your needs



Campbell Scientific Regional Offices

Australia

Location: Garbutt, QLD Australia
Phone: 61.7.4401.7700
Email: info@campbellsci.com.au
Website: www.campbellsci.com.au

Brazil

Location: São Paulo, SP Brazil
Phone: 11.3732.3399
Email: vendas@campbellsci.com.br
Website: www.campbellsci.com.br

Canada

Location: Edmonton, AB Canada
Phone: 780.454.2505
Email: dataloggers@campbellsci.ca
Website: www.campbellsci.ca

China

Location: Beijing, P. R. China
Phone: 86.10.6561.0080
Email: info@campbellsci.com.cn
Website: www.campbellsci.com.cn

Costa Rica

Location: San Pedro, Costa Rica
Phone: 506.2280.1564
Email: info@campbellsci.com
Website: www.campbellsci.com

France

Location: Vincennes, France
Phone: 0033.0.1.56.45.15.20
Email: info@campbellsci.fr
Website: www.campbellsci.fr

Germany

Location: Bremen, Germany
Phone: 49.0.421.460974.0
Email: info@campbellsci.de
Website: www.campbellsci.de

India

Location: New Delhi, DL India
Phone: 91.11.46500481.482
Email: info@campbellsci.in
Website: www.campbellsci.in

South Africa

Location: Stellenbosch, South Africa
Phone: 27.21.8809960
Email: sales@campbellsci.co.za
Website: www.campbellsci.co.za

Spain

Location: Barcelona, Spain
Phone: 34.93.2323938
Email: info@campbellsci.es
Website: www.campbellsci.es

Thailand

Location: Bangkok, Thailand
Phone: 66.2.719.3399
Email: info@campbellsci.asia
Website: www.campbellsci.asia

UK

Location: Shepshed, Loughborough, UK
Phone: 44.0.1509.601141
Email: sales@campbellsci.co.uk
Website: www.campbellsci.co.uk

USA

Location: Logan, UT USA
Phone: 435.227.9120
Email: info@campbellsci.com
Website: www.campbellsci.com